



PBR-HD

POWER BAND RESAW

M/C Type:-

TEST No:-

INSTRUCTION MANUAL

Wadkin UltraCare Limited
Green Lane Road
Leicester
LE5 4PF

Tel: +44 (0)116 276 9111
Fax: +44 (0)116 259 8188
Website: www.wadkinultracare.com
E-mail: info@wadkinultracare.com

**MANUFACTURERS E.C. DECLARATION
OF CONFORMITY**

The following machine has undergone "Conformity Assessment" and has undergone Third Party Examination by a Notified Body in accordance with:-

Schedule IV of the Supply of Machinery (Safety) Regulations 1992
and Amendment No. 2063

COMPANY

Wadkin Ultracare Limited
Green Lane Road
Leicester
LE5 4PF

RESPONSIBLE PERSON

Mr J P Smith (Director)

MACHINE DESCRIPTION

TYPE Power Band Rasaw

MODEL PBR-HD

DIRECTIVES COMPLIED WITH

Supply of Machinery (Safety) Regulations 1992
Amendment No. 2063 1994
Draught Proposal CEN/TC 142
ISO 9001 Part 1

NOTIFIED BODY

Lloyds Register
Lloyds Register House
29 Wallisley Road
Croydon, CR0 2AJ

**SIGNED ON BEHALF OF WADKIN
ULTRACARE LTD.**



**EC TYPE EXAMINATION
CERTIFICATE NO.**

EC95/00004

BE CAREFUL
THIS MACHINE CAN BE DANGEROUS
IF IMPROPERLY USED

Always use guards.

Keep clear until rotation has ceased.

Always operate as instructed
and in accordance with good practice.

Read all of the instruction manual before
installing, operating or maintaining machine.

Manufactured by :- WADKIN LTD
Green Lane Road
Leicester
LE5 4PF
England

phone no :-0116 2769111
fax no :-0116 2598138



CONTENTS

Section	Page
<i>Health & Safety</i>	2
<i>Safety Procedures</i>	4
<i>General Information</i>	6
<i>Noise Emission Values</i>	7
<i>Machine Specification</i>	9
<i>Main Components Of The PBR-HD</i>	10
<i>Standard Items Despatched</i>	12
<i>Cleaning</i>	12
<i>Wiring Details</i>	12
<i>Lubrication</i>	12
<i>Slinging Instructions</i>	13
<i>Foundation Drawing</i>	14
<i>Machine Commissioning</i>	15
<i>Fitting Of Resaw Blades</i>	15
<i>Setting Saw Guides</i>	17
<i>Belt Tension Adjustment</i>	19
<i>Drip Feed Unit</i>	20
<i>Split Level Fence</i>	21
<i>Feeding Unit</i>	22
<i>Controls</i>	23
<i>Table Insert</i>	23
<i>The Resaw Blade</i>	24
<i>Cutting With The PBR/HD</i>	25
<i>Setting Up To Rip</i>	26
<i>Resaw Blade Maintenance</i>	28
<i>Optional Extras</i>	29
<i>Illustrated Parts List</i>	30

HEALTH AND SAFETY

The CE mark on this machine signifies that an EC declaration of conformity is drawn up indicating that the machine is manufactured in accordance with the Essential Health and Safety Requirements of the 'Supply of Machinery (Safety) Regulations 1992'.

The 'requirements for supply of relevant machinery' in the General Requirement of the Regulations are not only that the machine satisfies the relevant essential health and safety requirements, but also that 'the manufacture.....carries out the necessary research or tests on components, fittings or the complete machine to determine whether by its design or construction the machine is capable of being erected and put into service safely'.

Persons who install this machine have duties under the 'Provision and Use of Work Equipment Regulations 1992'. An indication of these duties is given in the following extracts, but the user should be familiar with the full implications of the regulations.

REGULATION 5 requires that:

Every employer shall ensure that work equipment is so constructed or adapted as to be suitable for the purpose for which it is used or provided.

In selecting work equipment, every employer shall have regard to the working conditions and to the risks to health and safety of persons which exist in the premises or undertakings in which that work equipment is to be used and any additional risk posed by the use of that work equipment.

Every employer shall ensure that work equipment is used only for the operations for which, and under conditions for which, it is suitable.

In this regulation 'suitable' means suitable in any respect which it is reasonably foreseeable will affect health or safety of any person.

The Provision and Use of Work Equipment Regulations also include requirements as follows:-

regulation 6 - maintenance

regulation 7 - specific risks

regulation 8 - information and instructions

regulation 9 - training

Note:-

Attention is drawn to those requirements of the 'Woodworking Machines Regulations 1974' which are not replaced by the Supply of Machinery (Safety) Regulations or other, eg; Regulation 13 of the Woodworking Machinery Regulation, - 'Training', still applies.

Whilst the prime duty for ensuring health and safety rests with employers, employees too have legal duties, particularly under sections 7 and 8 of the Health and Safety at Work Act. They include:

Taking reasonable care for their own health and safety and that of others who may be affected by what they do or don't do;

co-operating with their employer on health and safety;

not interfering with or misusing anything provided for their health, safety and welfare.

These duties on employees have been supplemented by regulation 12 of the Management of Health and Safety at Work Regulations 1992. One of the new requirements is that employees should use correctly all work items provided by their employer in accordance with their training and the instructions they receive to enable them to use the items safely.

Noise

Noise levels can vary widely from machine to machine depending on the conditions of use. Persons exposed to high noise levels, even for a short time, may experience temporary partial hearing loss and continuous exposure to high levels can result in permanent hearing damage.

The Noise at Work Regulations 1989 place legal duties on employers to prevent damage to hearing.

There are three action levels of noise defined in regulation 2;

The first action level;-

a daily personal noise exposure (L_{EPA}) of 85dB(A)

The second action level;-

a daily personal noise exposure (L_{EPA}) of 90dB(A)

The peak action level

a peak sound pressure of 200 pascals (140dB re 20pa)

The exposure level is obviously influenced by the emission level of all the equipment in use.

Emissions levels for machines are provided in the particular machine instruction manual.

These levels are measured in accordance with ISO 7960 under certain specified test conditions, they do not necessarily represent the highest noise level, which is influenced by many factors, eg number of spindles in operation, type and condition of work piece, spindle speeds etc.

For regulations and information on relevant personal protective equipment i.e ear defenders, employers should refer to the Personal Protective Equipment at Work Regulations 1992.

Dust

Wood dust can be harmful to health by inhalation and skin contact and concentrations of small particles in the air can form an explosive mixture.

The Control of Substances Hazardous to Health Regulations (COSHH) 1989 place legal duties on employers to ensure that:-

the exposure of his employees to substances hazardous to health is either prevented or, where this is not reasonably practicable, adequately controlled.

.....adequate control to exposure of employees to a substance hazardous to health shall be secured by measures other than the provision of personal protective equipment.

where the measures taken in accordance with the paragraph above do not prevent or provide adequate control of, exposure to substances hazardous to the health of employees, then in addition to taking those methods, the employer shall provide those employees with such suitable personal protective equipment as will adequately control their exposure to substances hazardous to health.

Instructions for Use

Machinery manufactures are required by the Supply of Machinery Safety Regulations to provide comprehensive "Instructions for Use" of equipment. It is important that this information is transmitted to the person using the machine.

IMPORTANT

SAFETY PROCEDURES AND CONSIDERATIONS

To ensure safe working conditions, persons operating and assisting with the operation of this machine must ensure that they read and fully understand the instructions given within this manual and have received sufficient training in the use of the machine and the safety aspects to be observed.

Note:- Persons under the age of 18 years must not operate the machine except during the course of training under the supervision of a trained operator.

A) POINTS TO NOTE BEFORE OPERATING OR ASSISTING WITH THE OPERATION OF THE MACHINE.

- 1) You have read and understand the operation and safety aspects of the machine and have been checked out by a qualified supervisor.
- 2) The machine is supplied with full safe guarding. The machine shall not be operated unless the safe guardings are in position and are functional.
- 3) Re-saw blades are the correct type, suitable for the machine and working conditions, rotate in the correct direction of cut, are sharp and correctly fitted.
- 4) Correct speeds are selected for the cutter equipment and working conditions.
- 5) Loose clothing is either removed or securely fastened back and jewellery removed.
- 6) Adequate working space and lighting is provided.
- 7) All dust extraction equipment is switched on, properly adjusted and working adequately.
- 8) The machine is securely installed (refer to Installation section within this manual).
- 9) The machine should only be used for cutting wood or materials with physical and technological characteristics similar to wood, and for which the chip or particle removal process is similar.

B) DURING MACHINING:-

- 1) Wear suitable protective clothing e.g, approved eye protection, ear defenders and dust masks. Gloves shall be worn when handling sharp edge saws.
- 2) Stop the machine using the emergency stop or at the mains isolator before making adjustments, cleaning or carrying out maintenance.
- 3) Keep the floor area around the machine clean and free from wood refuse. Do not allow the floor around the machine to become slippery.
- 4) Stop the machine and report immediately to a person in authority any actual or potential malfunction or operator hazard. Do not attempt to repair or rectify the machine unless qualified or authorised to do so.
- 5) The operator must not leave the machine running whilst unattended.
- 6) Never by-pass interlocks.
- 7) A push stick or handled push block must be used to feed the trailing edge of a workpiece past the cutting blade or into the feed rollers.
- 8) When ripping never stand directly behind the material.

WARNING:-

Failure to observe correct operating procedures prior to and during operation of this machine can result in severe injury.

DO NOT attempt to operate the machine while under the influence of anything that reduces your alertness.

GENERAL INFORMATION

The PBR-HD resaw machine has two pulleys, one vertically above the other. The top pulley can be adjusted vertically to tension the saw correctly and can also be tilted slightly to 'track' the saw so that it runs steadily without wandering over the pulley face.

Cutting is done by the down run of the blade between the top pulley and the table. The saw blade is completely guarded except for the operative portion. Hinged covers on the guarding enclosure allow access for maintenance.

The length of blade which is exposed varies according to the thickness of material being cut but the top guide should always be set

as low as possible to keep the exposed length to a minimum.

Timber is fed through the machine by driven toothed rollers which are mounted on a spring tensioned swinging arm. Drive to the feed rollers is variable and is adjusted via a handwheel on the end of the motor. A two tier multi-roller fence provides support for the feed rollers whilst ensuring a smooth passage for the work piece. The top row of fence rollers may be quickly removed to assist blade guidance for running accuracy when machining smaller stock.

A canting table, tilting up to 35 degrees, allows for angled timber sawing.

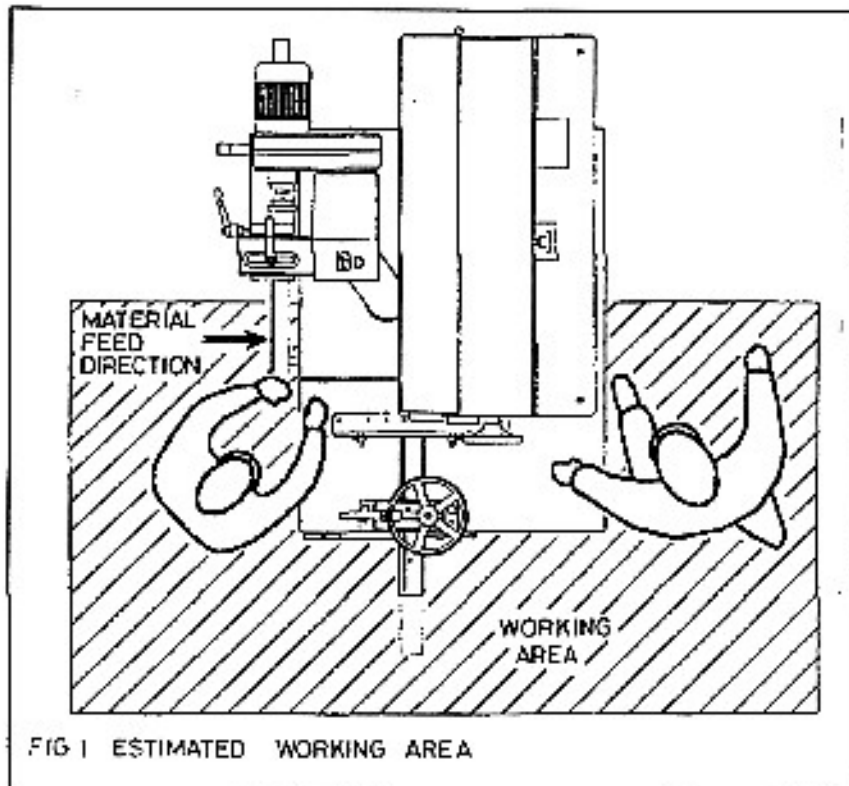

NOISE EMISSION VALUES

Machine criteria

The machine was free standing on a concrete floor, not bolted down and not mounted on any vibration dampening. A flexible pipe connected the machine to the dust extraction. There was no sound enclosure around the machine.

Machine cutting criteria

Saw motor	11 kw
Saw motor speed	3000 rev/min
Feed motor	0.75 kw
Feed motor speed	1500 rev/min
Speed of saw	1800 M/min
Feed rate:-	15 M/min
Cut width:-	150mm

Material criteria

Material:- soft wood medium grade
Moisture content:- 8-14%
limber size:- 150mm x 150mm
processed down to
a final width of
150mm x 50mm.
Preliminary machining:- none

Tooling criteria

The standard PBR-HD machine was fitted with a 75mm wide blade, 5.08 meters long, tooth pitch of 44.5mm, blade width 1mm and a kerf of 0.89mm.

Noise levels

The figures quoted in the noise emission chart are emission levels and are not necessarily safe working levels.

Whilst there is a correlation between emission levels and exposure levels, this cannot be used reliably to determine whether or not further precautions are required to achieve safe working levels.

Factors that influence the actual level of exposure to the work force include the duration of exposure, the characteristics of the work room, sources of noise etc i.e the number of machines and other adjacent processes. Also the permissible exposure levels can vary from country to country.

Emission levels, however will enable the user of the machine to make a better evaluation of the 'hazard and risk'.

NOISE EMISSION CHART		
MODEL:- PBR		
TYPE :- HD 50HZ 415V		
DECLARED NOISE EMISSION VALUES in accordance with ISO4871		
	Idling	Operating
Declared A-weighted sound power level (L_{wA}) in dB re $1pW$	92.25	101.23
Declared A-weighted emission sound level (L_{pA}) in dB re 20 μ Pa at the operators position	78.40	87.38
Environmental correction factor (K)	= 3	
values determined according to specific test code ISO7960 Annex J		

MACHINE SPECIFICATION

Diameter of saw wheels		700mm	(27.5")
Maximum depth under saw guide		325mm	(13")
Multi-roller fence opening		230mm	(9")
Maximum opening to feed		365mm	(18")
Maximum distance to saw body		680mm	(26.7")
Maximum width of blade		78mm	(3")
Minimum width of blade		63.5mm	(2.5")
Minimum width of blade using optional guides		6mm	(0.25")
Maximum length of blade		5070mm	(200")
Minimum length of blade		4945mm	(194")
Table height		910mm	(34.5")
Table size		775mm x 1035mm	(30" x 40")
Table cant		35 degrees	
Height of machine		2275mm	(89.5")
Saw motor speed	50 Hz	3000 rev/min	
	60 Hz	3600 rev/min	
Feed motor speed	50 Hz	1500 rev/min	
	60 Hz	1800 rev/min	
Saw motor power	50 Hz	11 kw	(15 hp)
	60 Hz	13.2 kw	(18 hp)
Feed motor power	50 Hz	0.75 kw	(1.0 hp)
	60 Hz	0.90 kw	(1.2 hp)
Star delta starter (UK and Europe)			
Saw speed		1800 M/min	(6000 ft/min)
Fully variable feed speed		5- 25 M/min	(15-80 ft/min)
Weight		685 kg	(1510 Lbs)

MAIN COMPONENTS OF PBR-HD RESAW

1. Top door
2. Bottom door
3. Table
4. Tracking adjustment
5. Table insert
6. Feeder slide bar
7. Feeder slide lock
8. Feed unit lock
9. Feed unit
10. Feed rate/timber size scale plate
11. Fence adjustment scale
12. Saw tension handwheel
13. Bottom saw guard
14. Top saw guard
15. Fence adjustment lock
16. Fence adjustment handwheel
17. Roller bed split fence
18. Top guides
19. Top guide lock
20. Top guide adjustment handwheel
21. Oil feed for wipers
22. Oil reservoir
23. Simpiabelt drive
24. Electrical box and isolator
25. Machine control panel
26. Variable speed handwheel

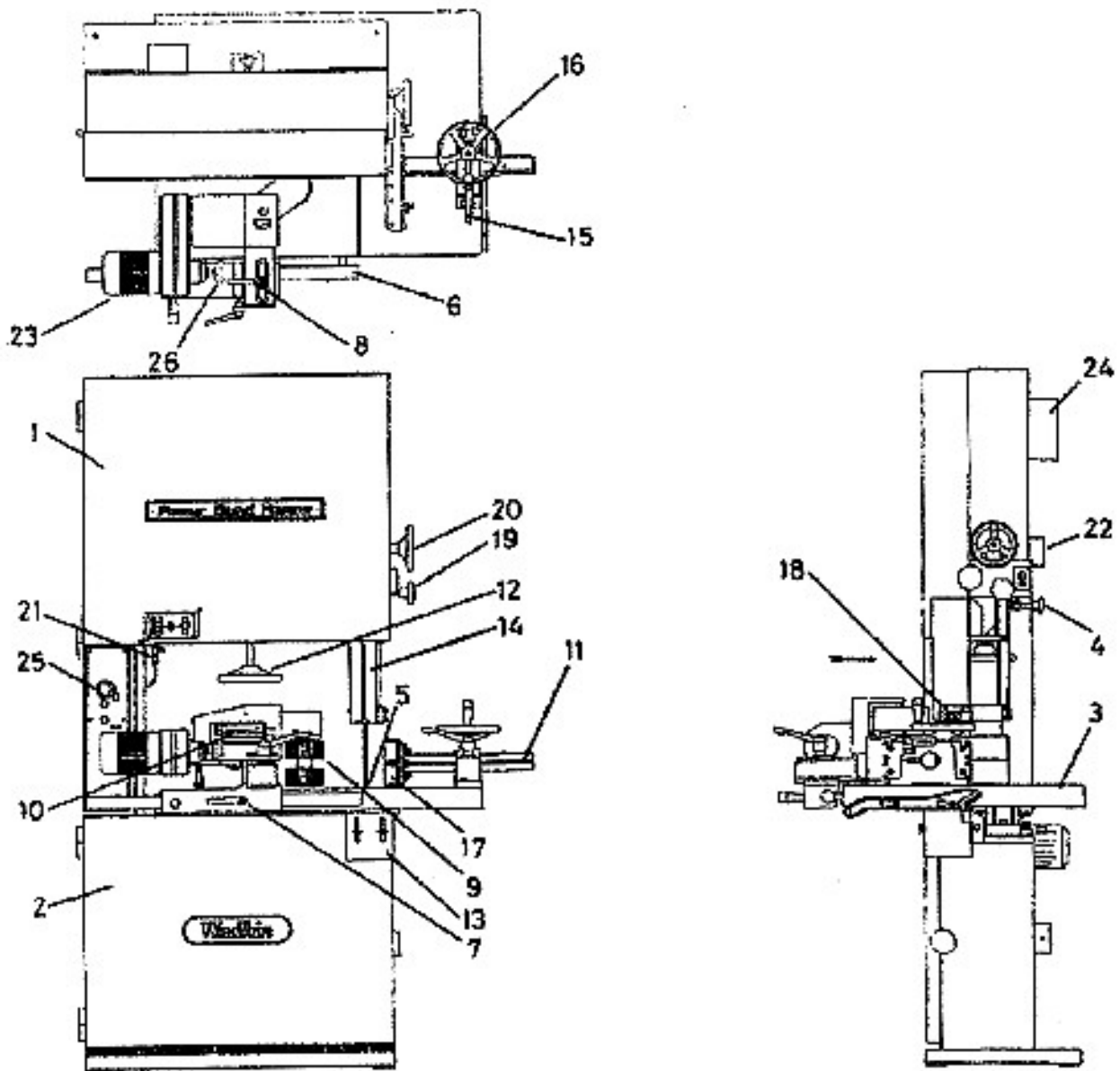

MAIN COMPONENTS OF THE PBR-HD RESAW

STANDARD ITEMS DESPATCHED WITH MACHINE

- | | |
|------------------------|---------------------|
| 1 - Instruction Manual | |
| 1 - 3mm allen key | 1 - 4mm allen key |
| 1 - 5mm allen key | 1 - 8mm allen key |
| 1 - 13mm spanner | 1 - 17/19mm spanner |
| 1 - 17/19mm spanner | 1 - 24mm spanner |

CLEANING

Clean protective coating from all bright parts by applying a cloth soaked in paraffin, turpentine or other suitable solvent.

WIRING DETAILS

The motor and control gear have been wired in before despatch. All that is required is to connect the power supply at the mains entry box.

Points to note when connecting power supply:-

1. Check the voltage, phase and frequency correspond to those on motor plate, also the correct coils and heaters are fitted to the starter.
2. It is important that the correct cable is used to give the correct voltage to the starter as running on low voltage will damage the motor.
3. Check the main line fuses are correct capacity. See fuse list inside starter cover.
4. Connect the line leads to the appropriate terminals. See wiring diagram, mains entry.
5. Check all connections are sound.
6. Check the rotation of the motor for the correct direction, if this is incorrect, reverse any two of the line lead connections at mains entry box.

LUBRICATION

All bearings are sealed for life and require no lubrication. Grease Feeder Unit at point indicated weekly.

It is advisable to keep all bright parts covered with a thin film of oil to prevent rusting.

BANDSAW SLINGING INSTRUCTIONS

To lift bandsaw proceed as follows:-

1. Use a sling with a minimum length of 5 metres (16 feet) with a safe working load to suit weight of machine.

Note:

APPROXIMATE NETT WEIGHT OF MACHINE 675 KG (1485 lbs)

APPROXIMATE GROSS WEIGHT OF MACHINE 705 KG (1551 lbs)

2. Open top door of machine and position sling around top frame and behind top wheel as shown in FIG 2 and 3.

Note:

To prevent damage to slings and frame, place rag between sling and frame as shown.

3. Secure top door as shown in FIG 4 and proceed to lift bandsaw slowly ensuring machine is not tilting at an angle.

IMPORTANT: Do not walk under machine during slinging operation.

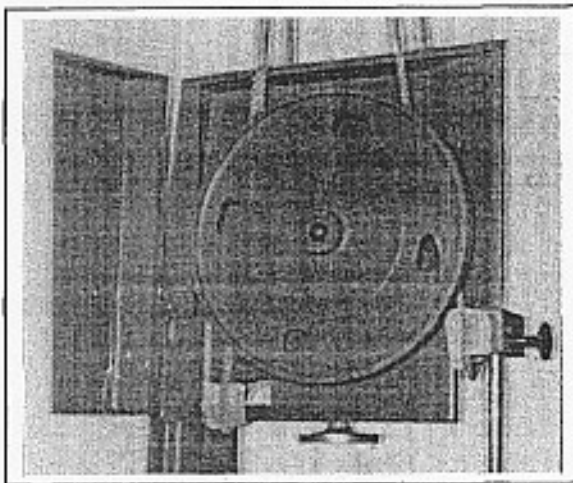

Fig 2

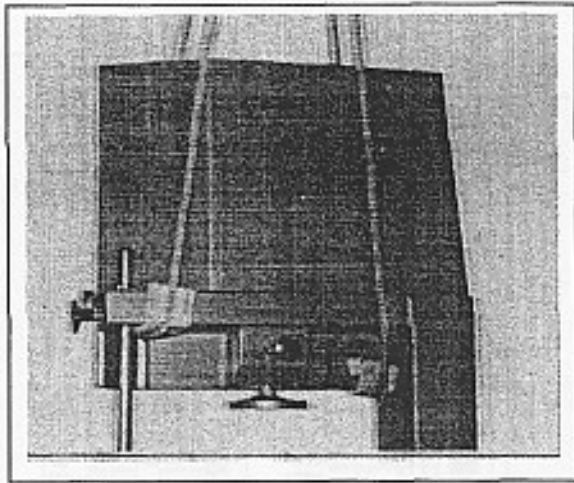

Fig 3

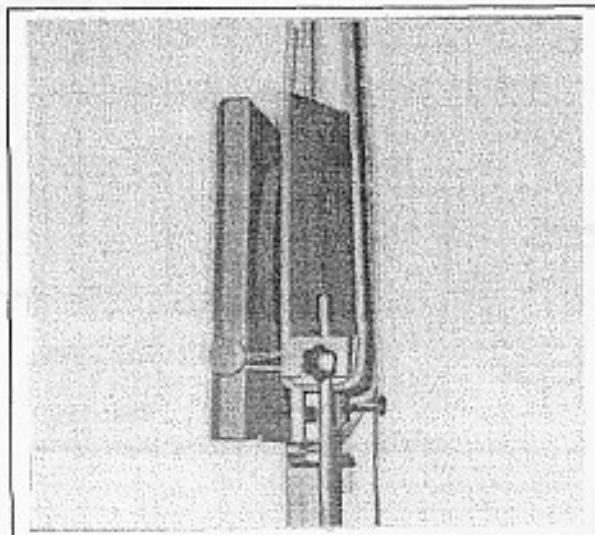
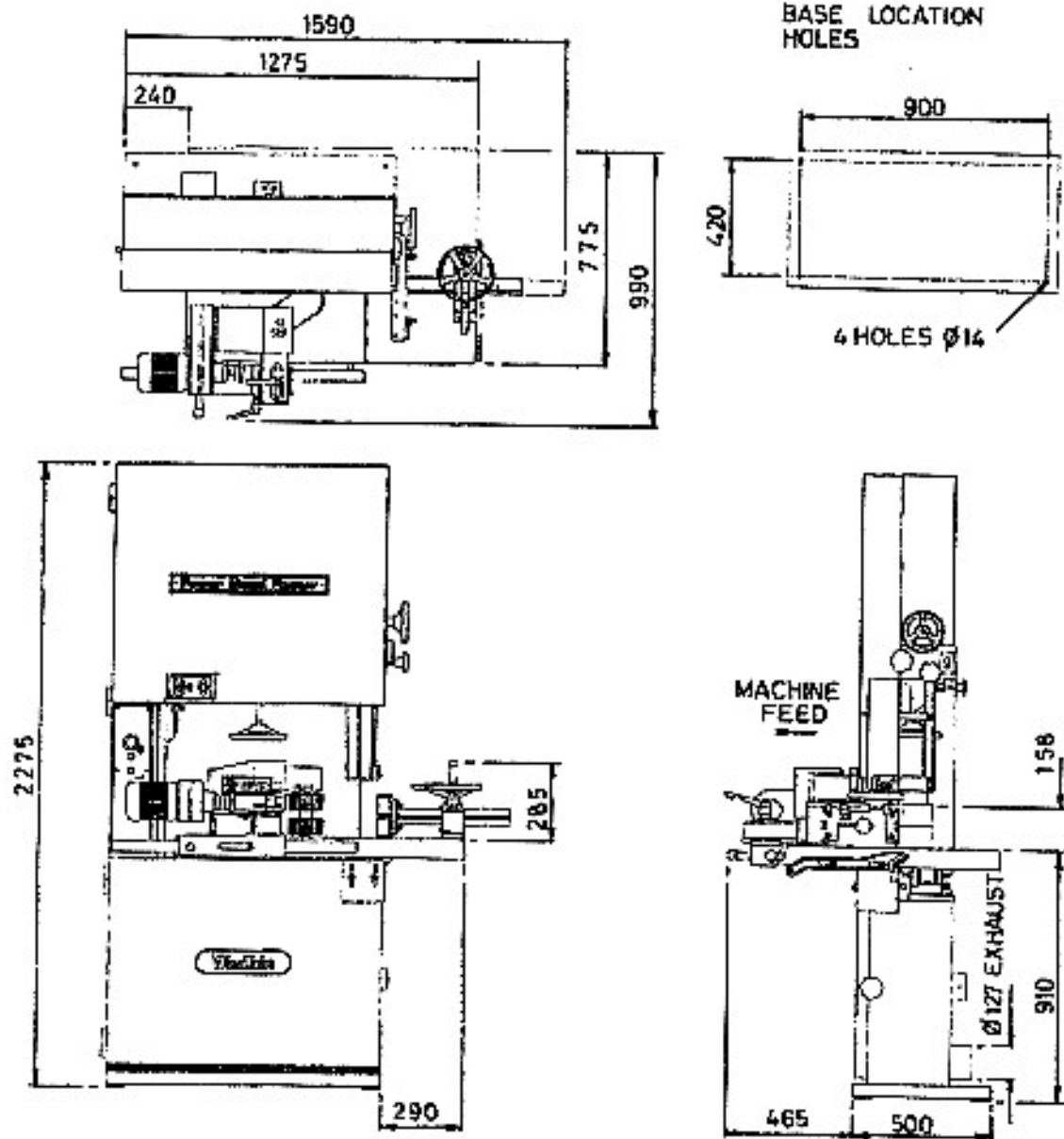

Fig 4

FOUNDATION

The machine is front loading and should be sited to allow working room for all capacities. Refer to foundation plan below and ensure floor is level, then mark floor for hole positions. Drill floor to suit 4-M10 rawbolts. These bolts are not provided with machine but can be supplied at an additional charge.



COMMISSIONING MACHINE

Machines generally are despatched fully assembled, except for some export markets when they are stripped and packed in cases when the assembly instructions provided inside case should be referred to.

1. Bolt machine to floor (see foundation)
2. Connect machine to power supply (see wiring details).
3. Clean protective coating from all parts (see cleaning).
4. It is recommended to connect machine to dust extraction plant. The built-in extraction outlet is 125mm (5" dia.) and requires 600 CFM for best results.

FITTING OF RESAW BLADES

1. Open doors fully.
2. Adjust top wheel with handwheel 'M' (fig 13) to allow saw to be positioned on top and bottom wheels and slot saw into guides (see FIGS 13 to 16).
NOTE:
 - a) The saw guards are fixed and should not be removed.
 - b) The saw guides are initially set at the works but may require slight adjustment.
3. Proceed to tension saw via saw tension handwheel 'M' (FIG 13) until pointer on scale reads PBR (see 'P' FIG 14).
4. Track blade by rotating top wheel by hand in a clockwise direction, the root of the saw tooth should project the rim of the wheel by approximately 2mm (see FIGS 12 and 14). Should the blade require tracking loosen nut 'B' (FIG 17) then turn handwheel 'C' (FIG 17) until saw is tracking correctly. Then tighten nut 'B'.

IMPORTANT: DO NOT TRACK BLADE WITH MOTOR RUNNING.

5. Adjust top wheel brush 'N;' (fig 14) onto tyre of top wheel.

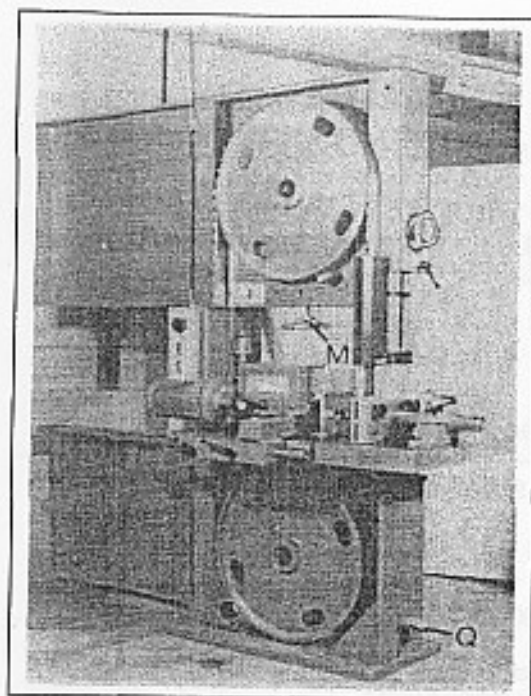

Fig 13

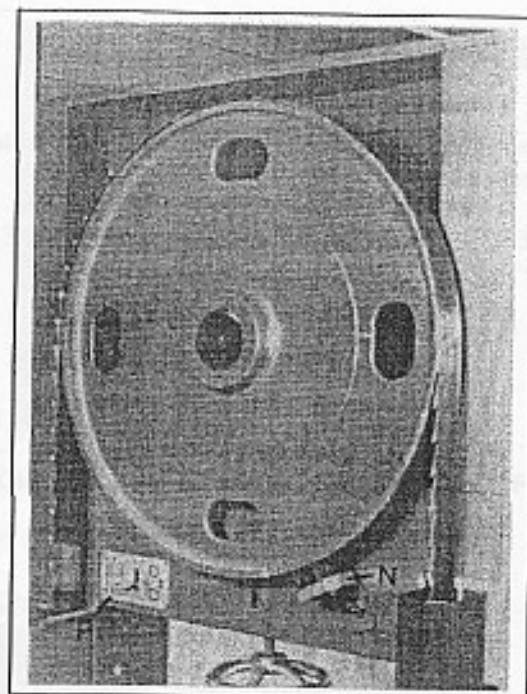

Fig 14

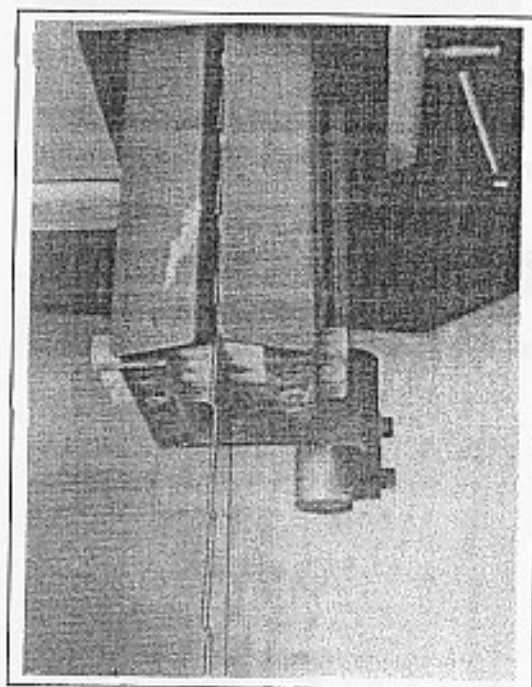

Fig 15

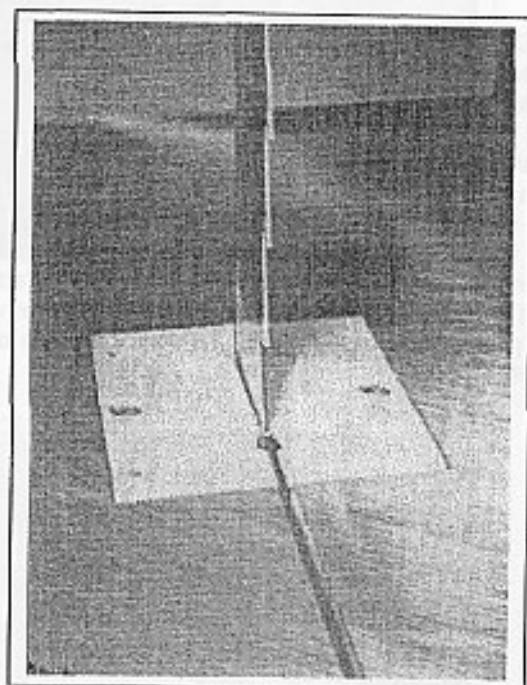

Fig 16

SETTING SAW GUIDES

The top saw guide unit is vertically adjustable by handwheel 'A' (FIG 18), and locked in desired position by locking handle 'B' (FIG 18).

BEFORE PROCEEDING TO SET TOP GUIDE ENSURE:-

1. Top guide is locked in position.
2. Isolate machine electrically.
3. Check blade is correctly tensioned and tracked.

PROCEED TO SET TOP AND BOTTOM GUIDES AS FOLLOWS:-

1. Slacken all M8 grub screws 'D' (FIGS 19 and 20).
2. Slide guide elements 'E' (FIGS 19 and 20) away from blade.
3. Proceed to adjust each guide element individually to just touch the blade (take care not to deflect blade from natural line) then lock in position with M8 grub screw.
4. Rotate blade by hand to ensure that blade runs free in guides.

NOTE:

The bottom guide has a fixed rear bearing 'F' (FIG 20) set clear of the back edge of the blade when correctly tracked.

This is provided as a device to stop blade running back into the machine should the blade be pushed back for any reason.

At this time it is good practice to check that the chip deflector plate 'H' (FIG 21) is in good condition and adjusted up to just clear the blade, this limits the amount of saw dust that can fall and be trapped between blade and bottom wheel when cutting therefore reducing the risk of premature blade failure. The wooden chip deflector plate is adjusted by loosening bolt 'J' (FIG 21).

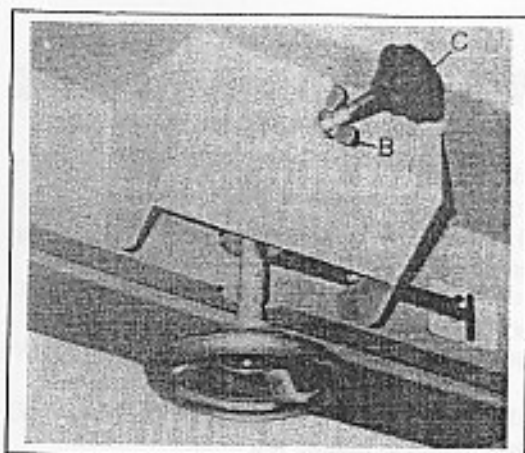

Fig 17

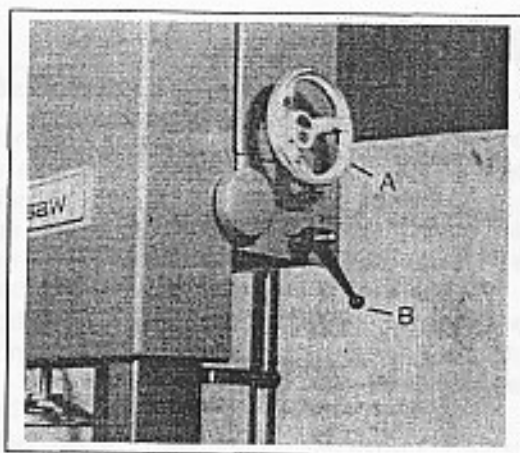

Fig 18

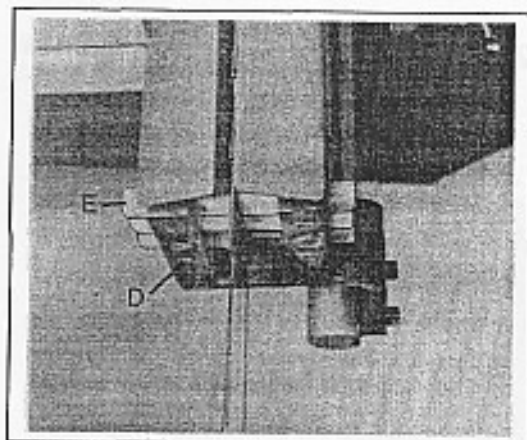

Fig 19

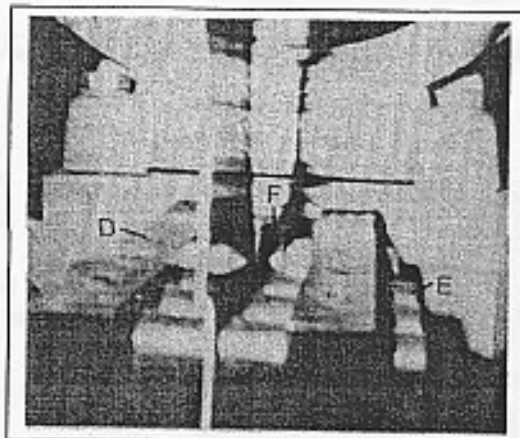

Fig 20

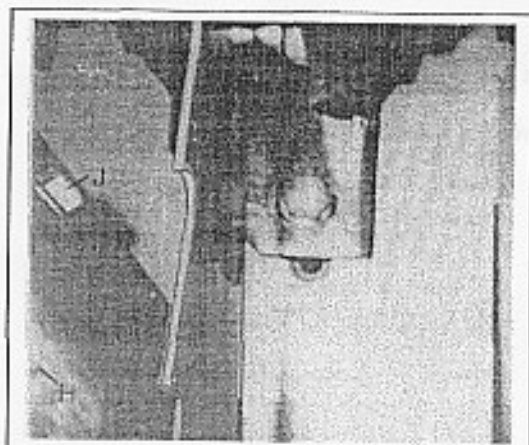

Fig 21

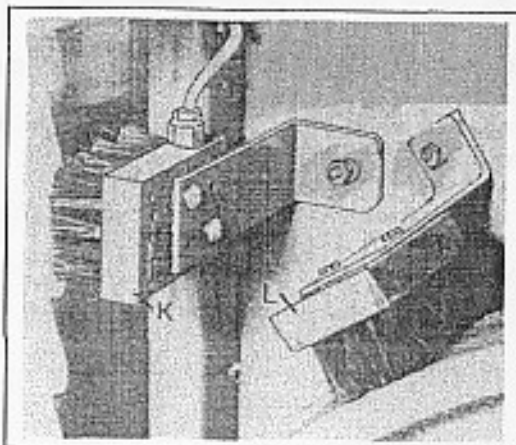

Fig 22

BELT TENSION ADJUSTMENT

Incorrect tension is the major cause of premature belt failure, some of its effects are as follows:

Under-tensioning results in incorrect driven speed caused by belt slip and also causes screeching on start up. This can be corrected by increasing tension.

Over-tensioning can be more serious. Apart from obvious damage to the belt, it can cause overheated, damage or burned out motor front end bearings. This is usually preceded by excessive stretch or too many take ups.

The POLY-V drive belt is correctly tensioned before the machine leaves the works.

After a period of time, the belt may start to slip due to run-in stretch and should be retensioned correctly as in "Belt Tension Adjustment".

BELT TENSION ADJUSTMENT

TO TENSION POLY-V-BELT, PROCEED AS FOLLOWS:-

1. Isolate machine electrically.
2. Open bottom door of machine.
3. Loosen 2 - M12 nuts. Securing motor to machine.
4. Attached to one of the motor mounting bolts is a vertical adjuster. Adjust M12 nut one turn at a time until screeching on start up is eliminated then tighten motor belts.

NOTE: DO NOT OVER TENSION BELT.

5. Close bottom door.

FOOTBRAKE (non CE Models Only)

A footbrake 'Q' is situated in the base of the machine as shown in Fig 13.

NOTE:

Always press main motor 'stop' button before depressing footbrake unless an electrically interlocked footbrake is fitted.

DRIP FEED UNIT, WHEEL AND BLADE BRUSHES

The purpose of this unit is to keep the wheels and blade clean. The mixture of fluid (i.e. Diesel, Paraffin, Oil) required will vary depending on the stock being sawn and a general guide is listed below.

Dry resin free material - generally no fluid required.

Average material - 1-1 Diesel or Paraffin and Oil.

Dry Resinous material - 2-1 Diesel or Paraffin and Oil.

Wet material - 1-2 Diesel or Paraffin and Oil.

The oil bottle 'A' (FIG 23) is turned On or Off by level 'B' (FIG 23) on top of the Oil bottle, and the flow adjusted by knurled screw 'C' (Fig 23). Generally the flow should be adjusted to 1 Drip/Sec.

Note:

Turn off fluid feed when not in use.

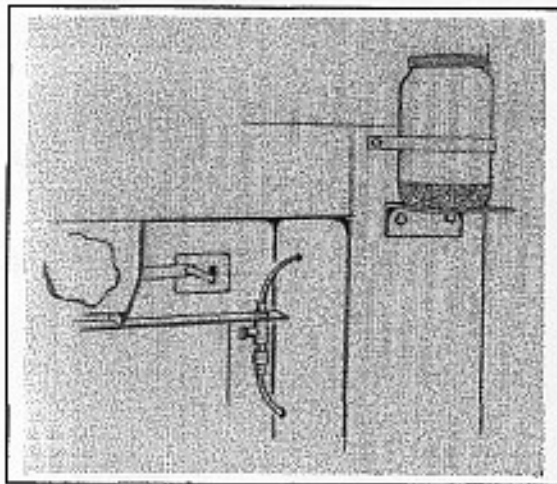

Fig 23

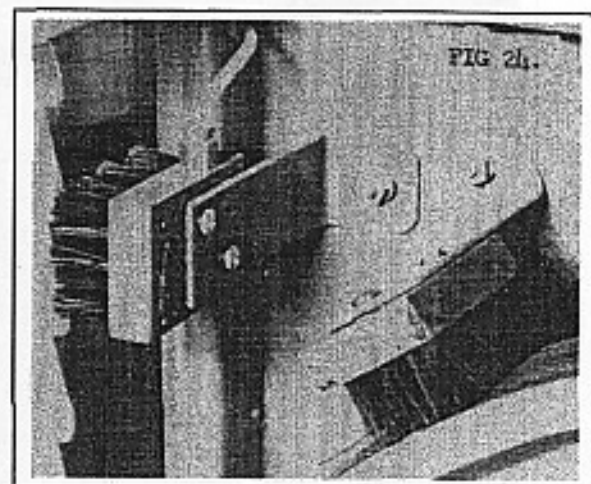

Fig 24

SPLIT LEVEL ROLLER BED FENCE

This unit has a blade to fence capacity of 230mm (9") and is adjusted by hand wheel 'A' (FIG 25) then locked in position by lock 'B' (FIG 25).

The roller bed is split by slackening 2 handles 'D' (FIG 25) and by removing top section 'C' (FIG 25), this allows top guide to be as close as practical to the stock when ripping small sections for increased accuracy.

The unit has a scale and adjustable pointer 'E' (FIG 25) for setting fence to desired stock size.

The bed rollers are made from a dry bearing nylon which requires no lubrication.

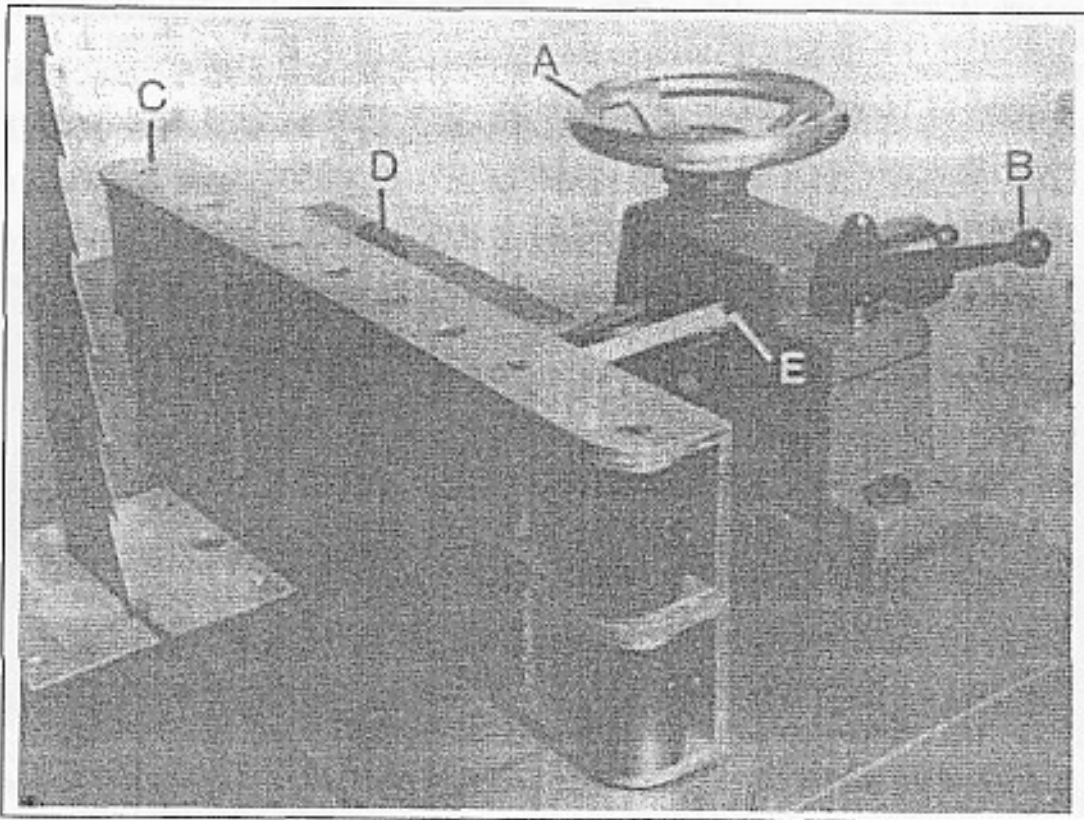

Fig 25

FEEDING UNIT

This unique feed unit has many features

1. The variable drive unit 'C' (FIG 26) gives feed speeds ranging from 5-25 m/min. (15-80 ft/min) and speed adjustment is by handwheel 'D' (FIG 26), a dial is fitted to indicate feed speed.

"DO NOT ADJUST WHILE DRIVE IS STATIONARY"

2. Feed rollers 'A' (FIG 26) are mounted on a swing arm 'B' (FIG 26) to cater for up to 100mm (4") variance in stock width this affords for example:-
 - a) Fast and easy positioning of feeder.
 - b) Random feeding of varying stock widths.
 - c) Refeeding wide stock when producing narrow boards.
 - d) Feeding tapered stock and waney edge boards.

The feeder to the fence capacity is 385mm (15") and slides on bar 'H' (FIG 26) in axis 'X' then locked in desired position by handles 'F' (FIG 26).

3. The feeder is also adjustable in axis 'Y' to enable top guide to be lowered close to stock when ripping shallow material with out fouling feed roller and to cater for patch of feed roller swing, particularly when table is canted for ripping angled stock.

IMPORTANT:

CHECK SWINGING ARM WILL NOT FOUL BLADE 'J' (FIG. 26) OR TOP SAW GUARD 'K' (FIG. 25) AFTER RE-POSITIONING FEED UNIT BEFORE OPERATING MACHINE.

4. A plate 'E' (FIG. 26) is fitted to feeder as a guide to feed speeds relative to stock depth to be sawn, however the feed speed selected should take into consideration the type of stock to be sawn and condition of the blade.
5. A grease point 'G' (FIG. 26) is provided, this point should be greased on a weekly basis depending on usage of machine.

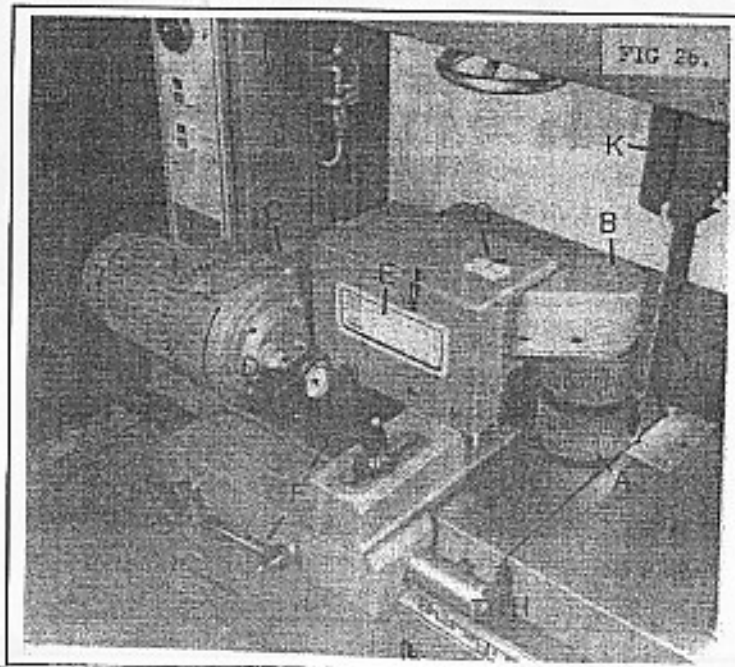

Fig 26

CONTROLS

The isolator 'A' (FIG. 27) is shown in the 'ON' position, the isolator should be switched to the 'OFF' position before making any adjustments to machine, carrying out any maintenance and while changing blades.

The 'STOP/START' button 'B' (FIG. 27) controls the saw motor and will not function unless the isolator is switched on.

The 'STOP/START' button 'C' (FIG. 27) controls the feed motor and will not operate unless the saw motor is running, after saw motor is switched on several seconds will elapse before feed control will function to allow main motor to switch automatically from STAR into DELTA windings.

Should either motor trip out there are 2 reset buttons provided on the contactor box on the rear of machine, if the machine trips out frequently the cause should be investigated and the main fuse rating checked or the overload settings adjusted.

TABLE INSERT

The table insert 'A' (FIG. 28) is replaceable should it be damaged or worn.

To change table insert remove 2-M6 allen button head screws 'B' (FIG. 28) and replace insert, set replacement insert flush with table and secure insert with the 2 - M6 allen button head screws.



Fig 27

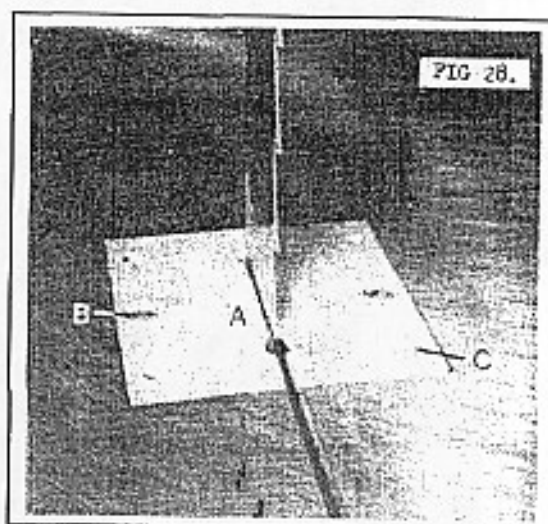

Fig 28

THE RESAW BLADE

For the best results it is recommended to use blades manufactured from "UDDEHOLM SWEDISH STEEL" to the following specification:-

1. 20 gauge x 78mm (3") wide x 45mm (1.75") pitch swage or stellite tipped.
2. Approximate length of blade 5070mm (16ft 2in).
3. Blade should be pretensioned across width - see 'A' (FIG. 29).
4. The blades should be "SWAGE TOOTH" FOR "SOFT WOODS" or "STELLITE TIPPED" FOR "HARDWOODS".
5. Service and doctor re-saw blades regularly.

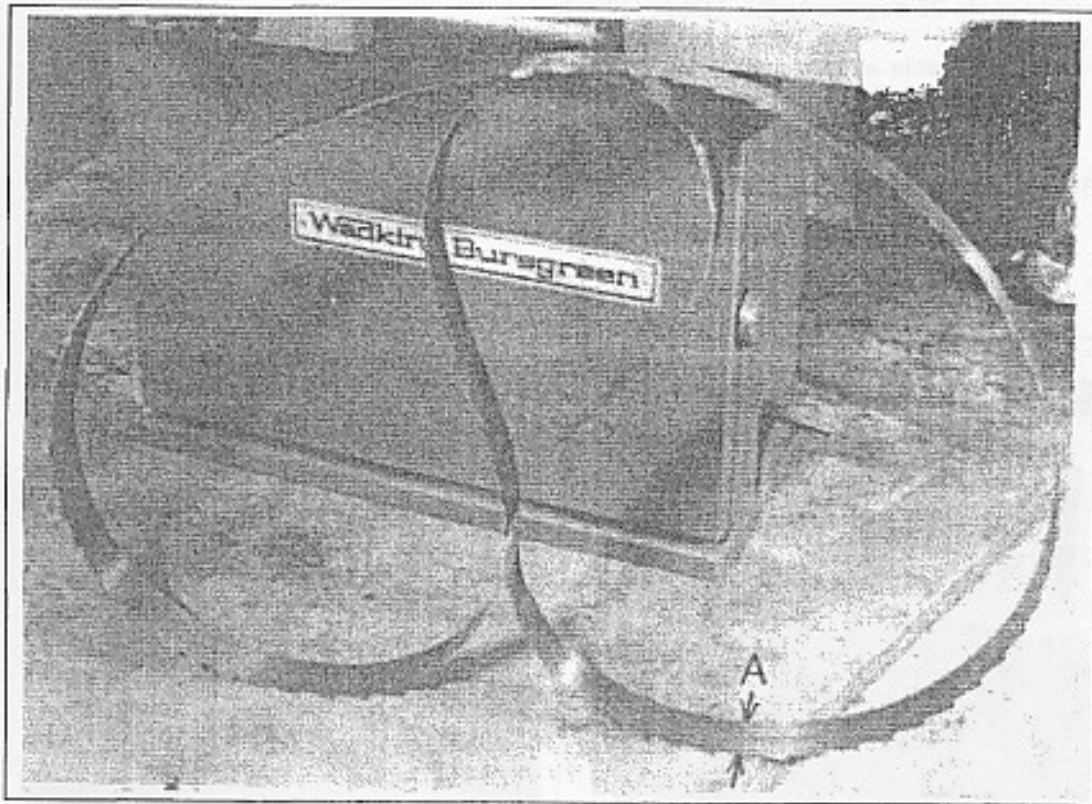

Fig 29

CUTTING WITH THE POWER BAND RESAW

Feed roller spring pressure

This pressure is pre-set at the works for the average type of work, however it may be desirable to adjust this to suit individual needs as follows:-

1. Short light stock (decrease spring pressure)
2. Long heavy stock (increase spring pressure)

To adjust spring pressure on feed roller 'A' (Fig 30)

1. Loosen caphead 'C' (FIG 30)
2. Rotate cam 'D' (FIG 30) to increase or decrease tension on spring 'B' (FIG 30).
3. Tighten caphead 'C' (FIG 30).
4. Check tension by pushing feed roller 'A' (FIG 30) back by hand.

Canting Table

The table cants 35 degrees to the right as follows:-

1. Support table weight.
2. Loosen nut 'A' (FIG 31).
3. Cant table to desired angle and relock nut 'A' (FIG 31)

NOTE: See options.

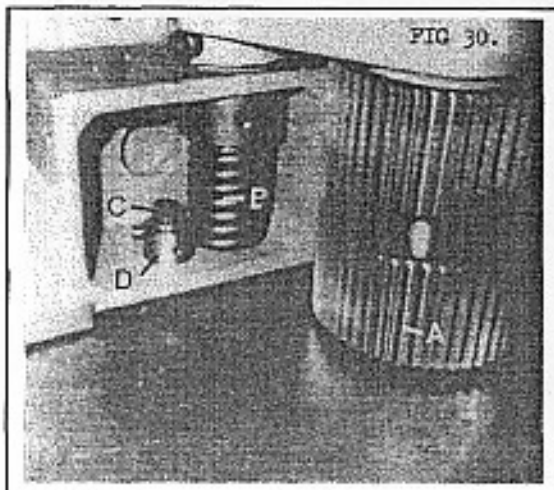

Fig 30

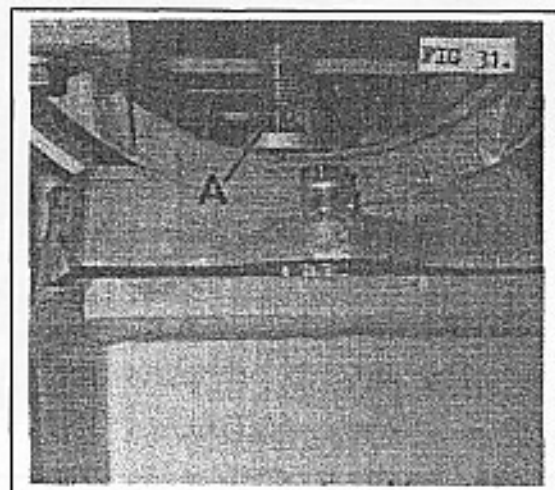

Fig 31

SETTING UP TO RIP

The versatility of the fence, feeder and guides provide many options when setting up to suit a wide variety of needs:-

- a) Wide shallow stock (FIG 32).
- b) Deep thin stock (FIG 33).
- c) Small sections (FIG 34).
- d) Wavy edge or tapered stock (FIG. 35).
- e) Feathered or angled stock (with table canted).
- f) Random feeding of stock with up to 100mm (4") variance in width.
- g) Re-feeding wide stock to produce thin boards without constantly re-positioning feed unit.

Procedure for setting up

- 1. Isolate machine.
- 2. Check blade is in good condition (change if necessary).
- 3. Check blade is correctly tensioned and tracked.
- 4. Set fence to finished stock width required (See 'A' FIG 32).
- 5. Adjust top guide (see 'B' FIG 33) as close as practical to suit stock depth, remove top fence section if necessary (see FIG 34).
- 6. Slide feed unit into position to suit stock being ripped so that the distance between the fence and the feed roller is smaller than the stock width, or the distance between the fence and the feeder body (see 'C' FIG 35) is greater than the stock width, Note: Maximum variance 100mm (4").
- 7. Check the feed arm and rollers will swing clear of the top guide and guard, adjust if necessary with locking handle 'D' (FIG 35).
- 8. Switch on machine, check and re-select feed speed (see chart 'E' FIG 35).

NOTE: Use the higher range of speeds for softwoods and the lower range for hardwoods relative to stock depth.

"IMPORTANT" - DO NOT ADJUST FEED ROLLERS WHILE UNIT IS STATIONARY.

- 9. Align stock with fence and push into feeder, check finished stock width, adjust fence if required, proceed to rip.

REMEMBER TO:-

- 1. Switch on extraction plant if fitted.
- 2. Turn on drip feed unit if required.

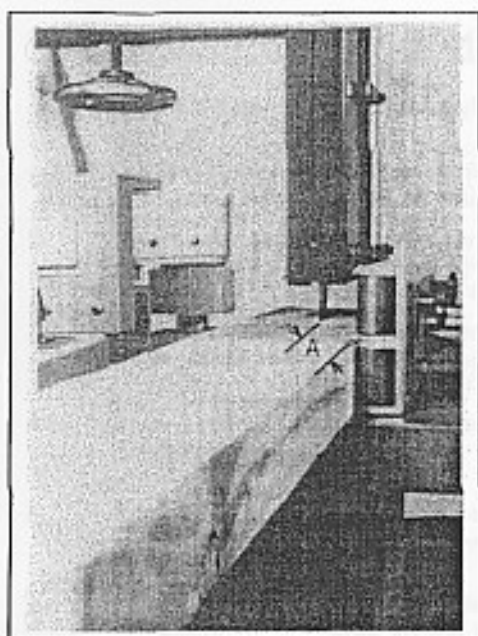

Fig 32



Fig 33

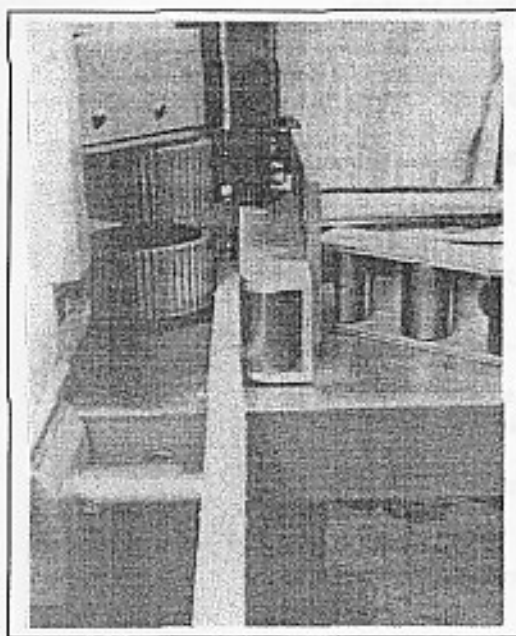

Fig 34

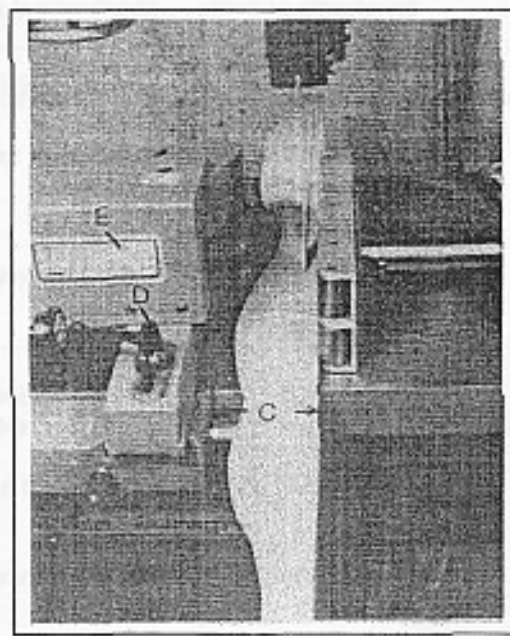

Fig 35

"IMPORTANT" RESAW BLADE MAINTENANCE

Failure to maintain re-saw blades will result in inaccurate ripping and very short blade life.

It is important that the blades are regularly maintained that is resharpener and retensioned by a saw doctor and that the tension is released from the saw blade when not in use.

It is usual practice for a re-saw blade to require maintenance after 4 hours running, the frequency at which maintenance will be required will depend to some extent on the following factors:-

1. Correct type of blade for ripping stock (i.e. soft or hard wood, swage or stellite tipped blade).
2. Correct feed speeds relative to depth of stock.
3. Correct tension applied to saw.

The following chart will assist you in fault finding.

<u>FAULT</u>	<u>CAUSE</u>	<u>REMEDY</u>
Blades unstable.	Tension run out of blade.	Return to saw doctor for retensioning.
	Build up of resin on wheels or blade	Clean wheels, blade and check wheel and blade brushes.
Inaccurate Ripping	Dull blade	Re-sharpen blade
	Insufficient tension applied to saw.	Check saw tension gauge
	Guides set incorrectly.	Re-set top and bottom saw guides.
Blades fracturing	Tension run out of blade	Return blades to saw doctor for re-tensioning.
	Overloading of saw.	Check feed speeds.
	Over running saw blade.	Check running time.
	Dirty blades and wheels.	Clean wheels, blade and Check brushes.
	Sawdust trapping between bottom wheel and blade.	Check condition and position of chip deflector blade.

OPTIONAL EXTRAS

1. Fine adjustment to table by screw and handwheel complete with scale and pointer. (Particularly useful for frequent canting of table).
2. Electrically interlocked foot brake. (Removes the need to depress stop buttons before applying foot brake and a useful safety feature). **NOTE: EX WORKS ONLY.**
3. An adjustable multi roller table 300mm (12") wide x 1965mm (6ft5in) long for use when ripping long stock at front and/or at rear of machine.
4. An adjustable single roller stand for use in front of machine when ripping long and heavy stock.
5. Return table and facility to give 300mm (12") fence opening. (Gives extra fence to blade capacity and facility to return stock for refeeding).
6. Fence section to facilitate 45 degree cutting. (Holds stock at 10 degrees to table with canting table facilitates angles between 35 and 45 degrees).
7. Electric interlock on top and bottom doors. (Controls will not function unless both doors closed, a good safety feature). **NOTE: ex works only.**
8. A top ball bearing guide for use with narrow bandsaw blades.
9. Various blades for wide and narrow band sawing.

ILLUSTRATED PARTS LIST

Item No.	Description
1	Main Frame
2	Top Wheel
3	Bottom Wheel
4	Feeder Bracket
5	Feeder Slide Bracket
6	Main Table
7	Motor Pulley
8	Roller Fence Bracket
9	Feeder Arm
10	Table Insert
11	Roller Fence Channel
12	Rule For Fence
13	Feed Speed Plate
14	Grease Plate
15	Feeder Guard
16	Feeder Arm Guard
17	Simplabelt Mounting Bracket
18	Guard Support Bracket
19	Balance Spring Bracket
20	Spring For Feeder
21	Guard Bracket
22	Bottom Guide Bracket
23	Deflector Plate
24	Top Sawguard
25	Pointer For Fence
26	Polyurethane Tyres
27	Guide Elements
28	Feed Roller Distance Piece
29	Feed Rollers
30	Fence Bar
31	Arm Pivot
32	Tension Spring Collar
33	Feeder Locking Stud
34	Fence Roller Spindle
35	Rollers For Fence
36	Spring Tensioner
37	Slide Bar
38	Guide
39	Top Guide Block
40	Bottom Guide Block
41	Top Brush Bracket
42	Rack Pinion Bracket
43	Spindle For Guide Post Bracket
44	Double Sprocket
45	Guide Post Sprocket
46	Sprocket
47	Sprocket

48	Brake Pedal (Non CE Machines Only)
49	Link Arm
50	Locking Washer Table & Feeder Bracket
51	Saw Tension Screw
52	Column Locking Screw
53	Under Table Saw Guard
54	Saw Tension Collar
55	Washer Guide Collar, Sprocket & Roller
56	Tension Indicator Plate
57	Saw Tension Pointer
58	Wheel Washer
59	Door Handle
60	Bearing
61	Bearing
62	Bearing
63	Poly Vee Belt
64	Plastic Handwheel
65	Plastic Ball
66	Kip Handle
67	Kip Handle
68	Chain
69	Balance Spring
70	Grease Nipple
71	Simplebelt Unit With Indicator
72	Oil Bottle
73	6" Handwheel
74	8" Handwheel

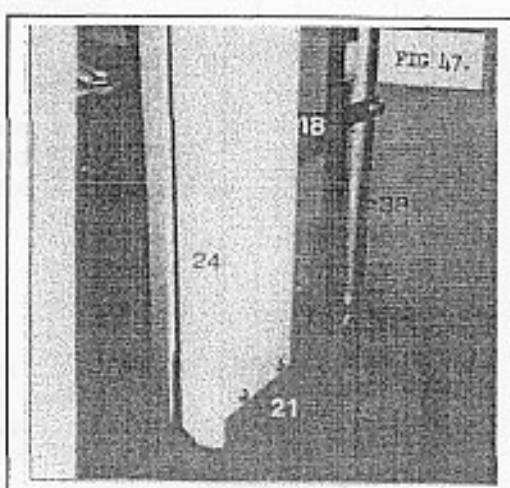
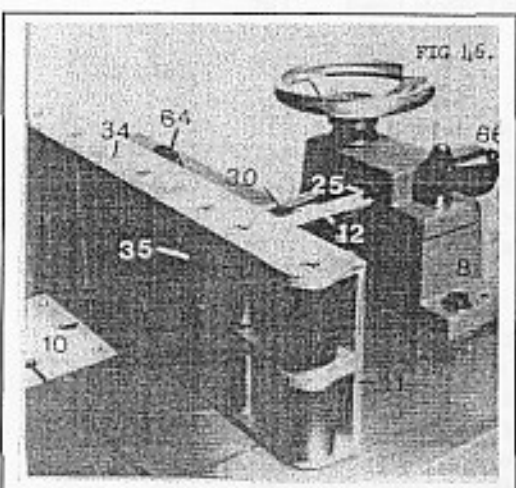
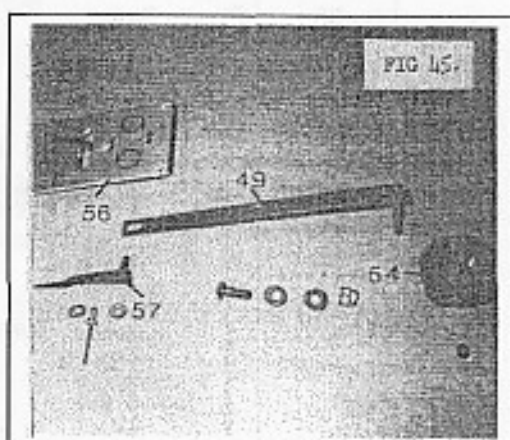
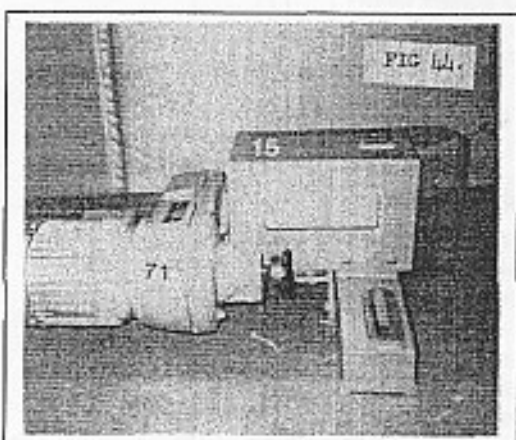
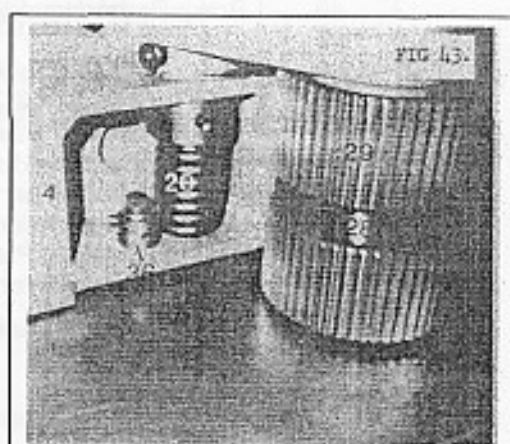
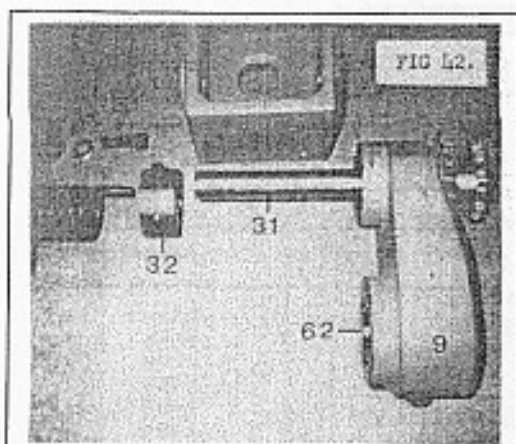

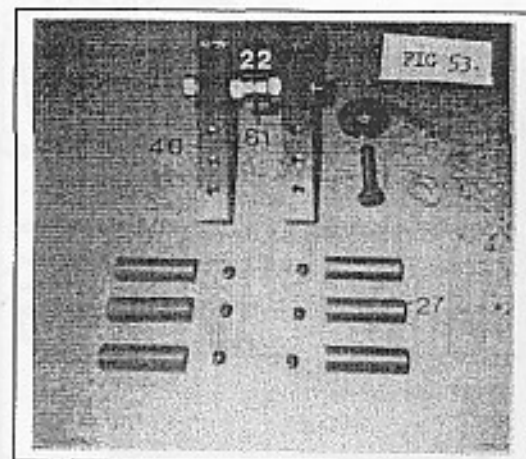
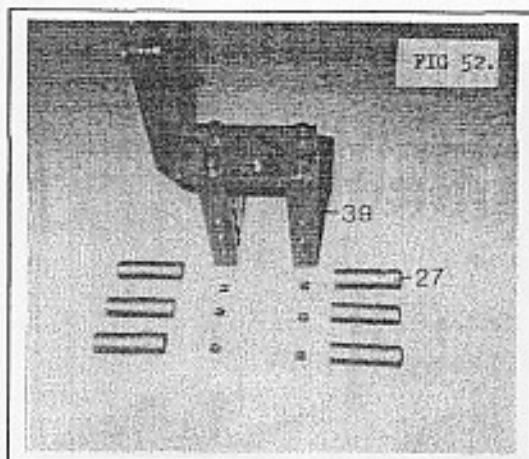
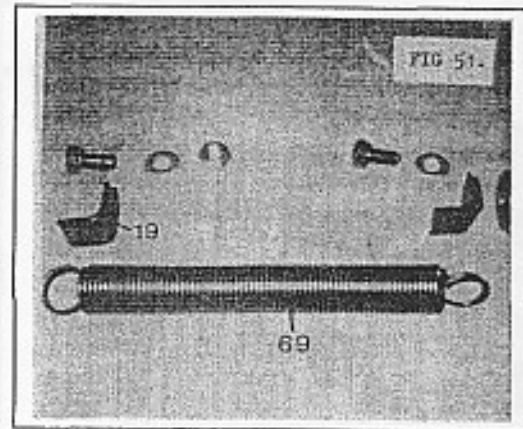
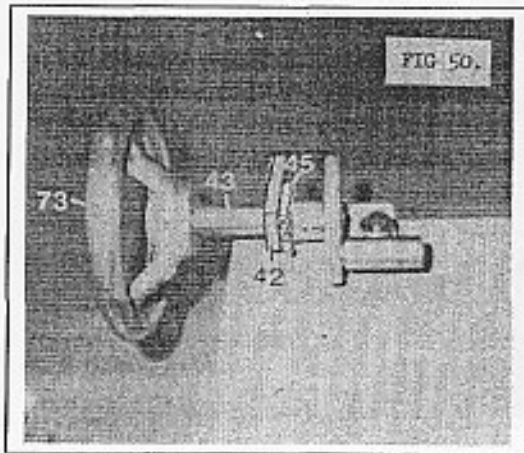
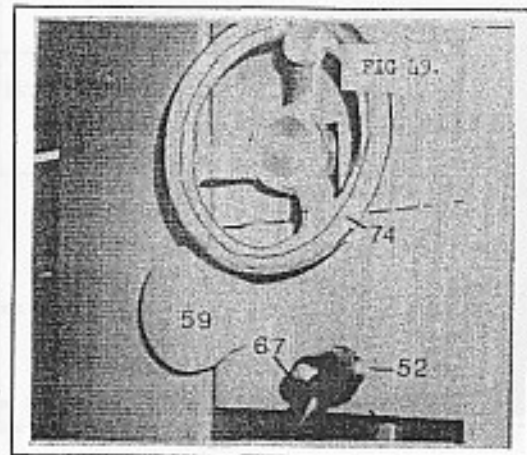
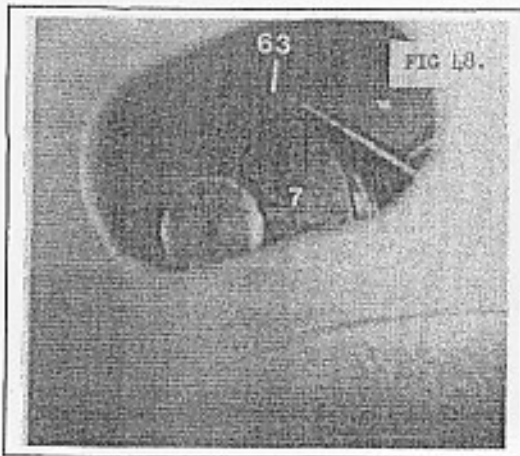

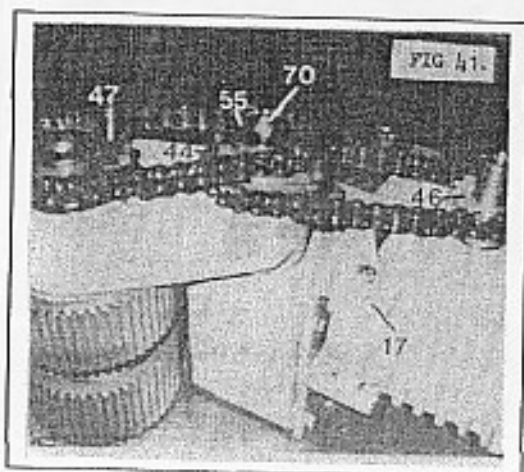
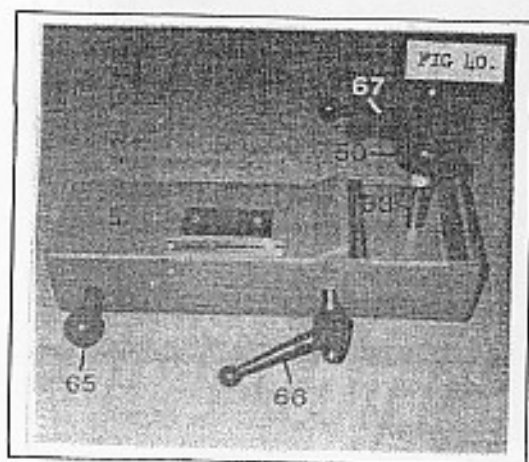
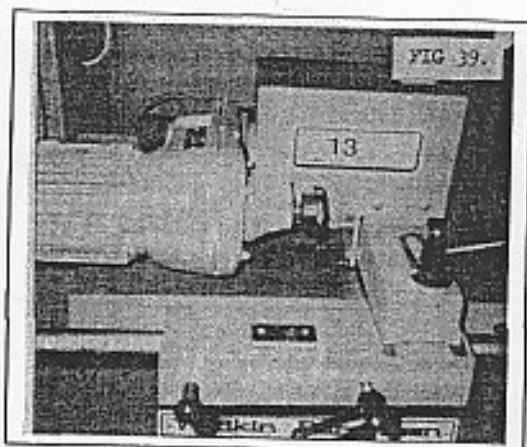
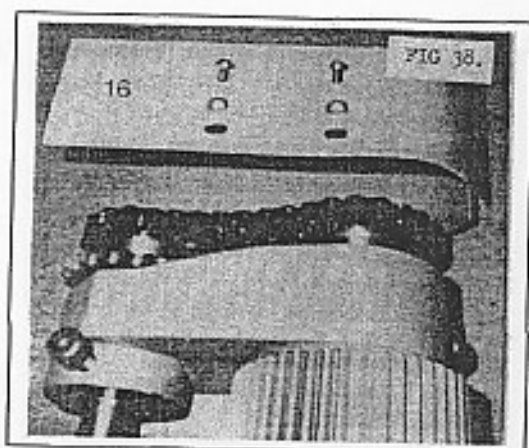
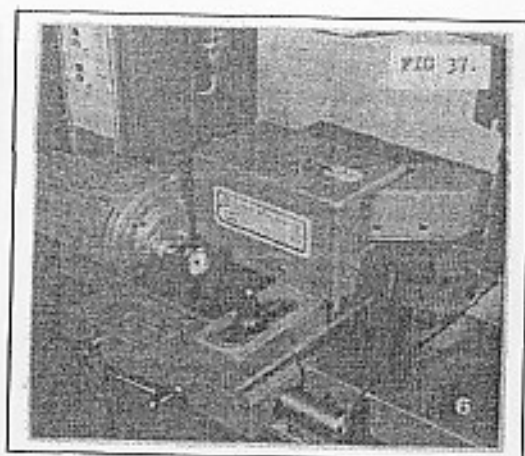
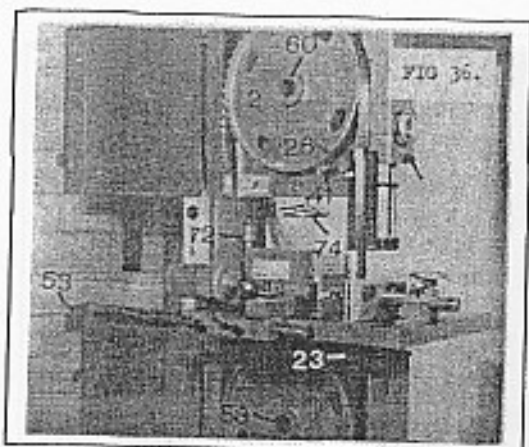



SIMPLABELT VARIABLE SPEED DRIVES

Simplatroll (Leads) Ltd.

- 1) Run Simplabelt unit to fastest speed.
- 2) Switch machine off.
- 3) Move adjustment handle (item 2) on drawing below), until minimum setting is achieved.
- 4) Remove outer cover (item 18 on drawing below).
- 5) Rotate pulley, by hand, and ease belt off gearbox pulley.
- 6) Refit now belt and reverse belt removal procedure.

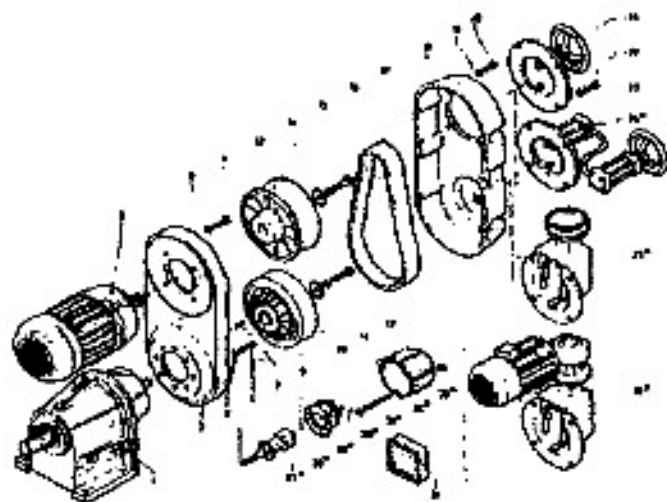

NGW/JP

7.2.85

Access No

Sheet 1 of 1

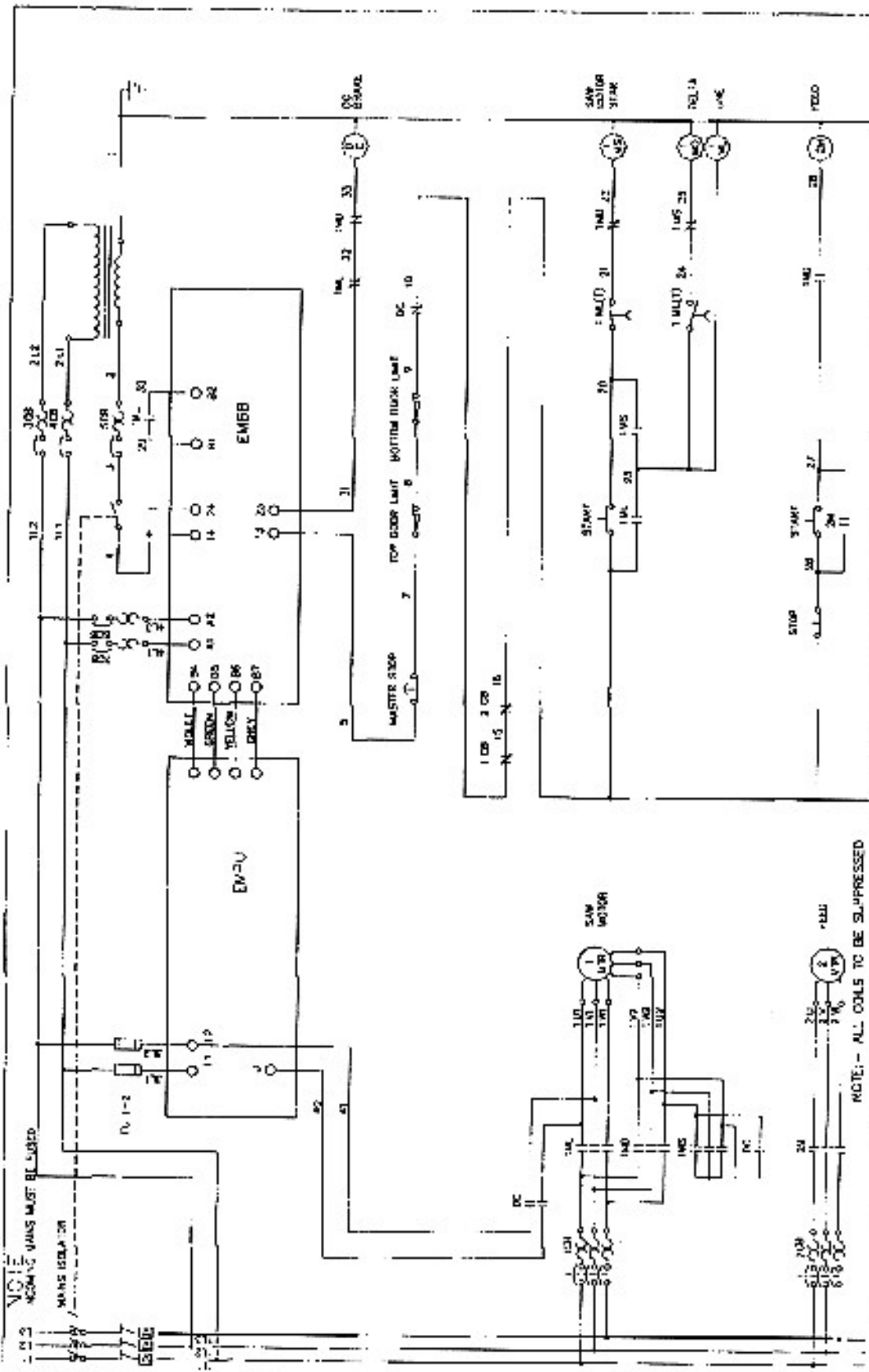

NOTE: ACOMATIC GAINS MUST BE LISTED
 MAINS ISOLATE ON

NOTE: - ALL COILS TO BE SUPPRESSED

	LILLISHER WOODWORKING DIVISION	Date: _____ No: _____ Date: _____ No: _____	Description: PBR DC BRAKING	Drawing No: 07415
	Date: _____ No: _____ Date: _____ No: _____	Description: PBR DC BRAKING	Drawing No: 07415	Drawing No: 07415

SERVICE CONTRACT **TERMS AND CONDITIONS**

1. The company's general terms and Conditions shall apply.
2. All service provided by the company in accordance with this agreement shall be carried out by employees of the company or by sub-contractors employed for that purpose.
3. The machines specified must be operated and maintained in accordance with instructions provided by the company, with due particular reference to maximum loadings.
4. The customer shall ensure that the company's employees, agents or sub-contractors have full and free access to the equipment at all reasonable times for the purpose of inspection and service.
5. The customer shall ensure that, when required by the company's employees, agents or sub-contractors, fully competent operating staff are on site to operate the equipment, to demonstrate any faults, and subsequently to verify the satisfactory operation of the equipment.
6. The customer shall ensure that the machines are clean, and provide, at no charge, adequate working space, power and lighting to enable the company to perform the services.
7. In the event of non-payment by the due date the company reserves the right to suspend performance of its obligations under this agreement until such payment is made.
8. The company reserves the right to make a charge for engineer's time and other costs and expense incurred in responding to a call for service where the cause of the fault was external to, or due to mis-use of the machines. Such would be made at the normal service rates applicable at the time of the visit.
9. This agreement will remain in force for one year, unless otherwise stated.
10. The company shall not be liable for any failure its obligations caused by an industrial dispute or any other cause beyond its control.