



# **JET**

**TENONING & END  
JOINTING SYSTEM**

**INSTRUCTION MANUAL No. 3003**

Health and Safety	Page 2 & 3
Specification	Page 4
Slinging	Page 8 & 9
Cleaning	Page 9
Foundation	Page 5, 8 & 9
Wiring Details	Page 6, 7 & 9
Lubrication	Page 10 & 22
Assembly of Machine	Page 10
Preparation for Operation where Pneumatics are fitted	Page 10
Safety Directives	Page 10
Start and Feed Control	Page 12
Inch Forward/Inch Reverse	Page 12
Master Stop	Page 12
Adjustable Stops	Page 12
Fixed Stops	Page 12
Oversize Timber Pressure Switch	Page 12
Vertical Adjustment of Table	Page 12
Horizontal Adjustment of Table	Page 12
Front End Stop	Page 12
Manual Shoulder Stops	Page 18
Pneumatic Shoulder Stops	Page 18
Manual Clamps	Page 18
Pneumatic Clamps	Page 18
Drive Belt Replacement	Page 20

For Replacement parts, Tool and Accessories  
Contact:

Wadkin Leicester  
Green Lane Works  
Leicester. LE5 4PF  
England  
Telephone: 0116 2769111  
Fax: 0116 259 8138

## **PREFACE**

### **IMPORTANT**

**IT IS OUR POLICY AND THAT OF OUR SUPPLIERS TO CONSTANTLY REVIEW THE DESIGN AND CAPACITY OF OUR PRODUCTS. WITH THIS IN MIND WE WOULD REMIND OUR CUSTOMERS THAT WHILE THE DIMENSIONS AND PERFORMANCE DATA CONTAINED HEREIN ARE CURRENT AT THE TIME OF GOING TO PRESS, IT IS POSSIBLE THAT DUE TO THE INCORPORATION OF THE LATEST DEVELOPMENTS TO ENHANCE PERFORMANCE, DIMENSIONS AND SUPPLIERS MAY VARY FROM THOSE ILLUSTRATED**

**THIS MANUAL IS WRITTEN AS A GENERAL GUIDE. A TYPICAL MACHINE IS SHOWN TO ILLUSTRATE THE MAIN FEATURES.**

**Failure to comply with instructions in this book may invalidate the guarantee**

# HEALTH & SAFETY

## SAFETY OF WOODWORKING MACHINES

Woodworking machines can be dangerous if improperly used. The wide range of work of which they are capable, requires adequate safeguarding arrangements against possible hazards.

Many injuries to machinists are caused by carelessness or failure to use the guards provided or to adjust them correctly.

The Bursgreen Divisions of Wadkin plc supply machinery designed for maximum safety which they believe, as a result of thorough testing, minimizes the risks inevitable in their use. It is the users responsibility to see that the following rules are complied with to ensure safety at work:

1. The operation of the machine should conform to the requirements of the Woodworking Machines Regulations 1974. All guards should be used and adjusted correctly.
2. Safe methods of working only should be adopted as given in the Health and Safety Work Booklet No. 41, "Safety in the use of Woodworking Machines", (obtainable from Her Majesty's Stationery Office)
3. Only personnel trained in the safe use of a machine should operate it.
4. Before making adjustments or clearing chips, etc., the machine should be stopped and all movement should have ceased.
5. All tools and cutters must be securely fixed and the speed selected must be appropriate for the tooling.

**Safety is our watchword but the user must comply with the above rules in his own interest. We would be pleased to advise on the safe use of our products.**



## Safety

CAREFULLY READ INSTRUCTION MANUAL WITH PARTICULAR REFERENCE TO THE FOLLOWING INSTRUCTIONS:-

- 1) SLINGING, ie, SAFE LIFTING LIMITS FOR SLINGS ETC.
- 2) INSTALLATION AND FOUNDATION, ie, SAFE WORKING AREA OF MACHINE AND BOLT POSITIONS, ETC.
- 3) WIRING DETAILS, ie, WIRING DIAGRAM AND INSTRUCTIONS FOR SAFE WIRING OF MACHINE.
- 4) MACHINE CONTROLS AND OPERATING INSTRUCTIONS.
- 5) SELECT CORRECT SPEED FOR CUTTER EQUIPMENT AND ENSURE CUTTERS ARE SECURELY LOCKED IN POSITION.
- 6) SET GUARDS CORRECTLY TO COVER CUTTER EQUIPMENT AS MUCH AS POSSIBLE.
- 7) NOTE START/STOP CONTROL POSITION AND ISOLATOR SWITCH POSITION (IF FITTED) BEFORE OPERATING MACHINE.
- 8) USE FEEDING DEVICES WHERE POSSIBLE.
- 9) REFER TO HEALTH AND SAFETY AT WORK BOOKLET No.41 (IN U.K.) FOR SAFETY IN THE USE OF WOODWORKING MACHINERY.

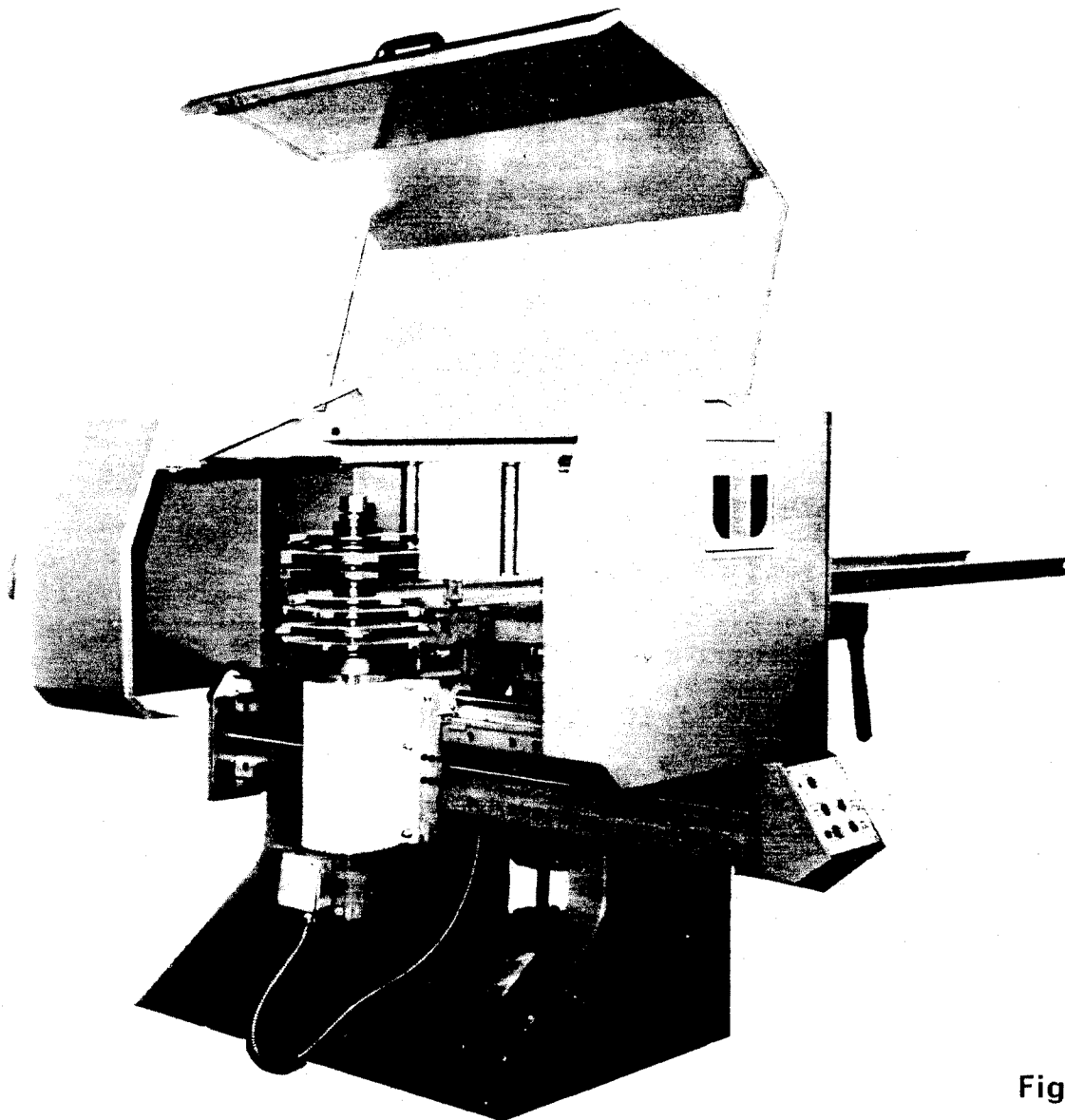
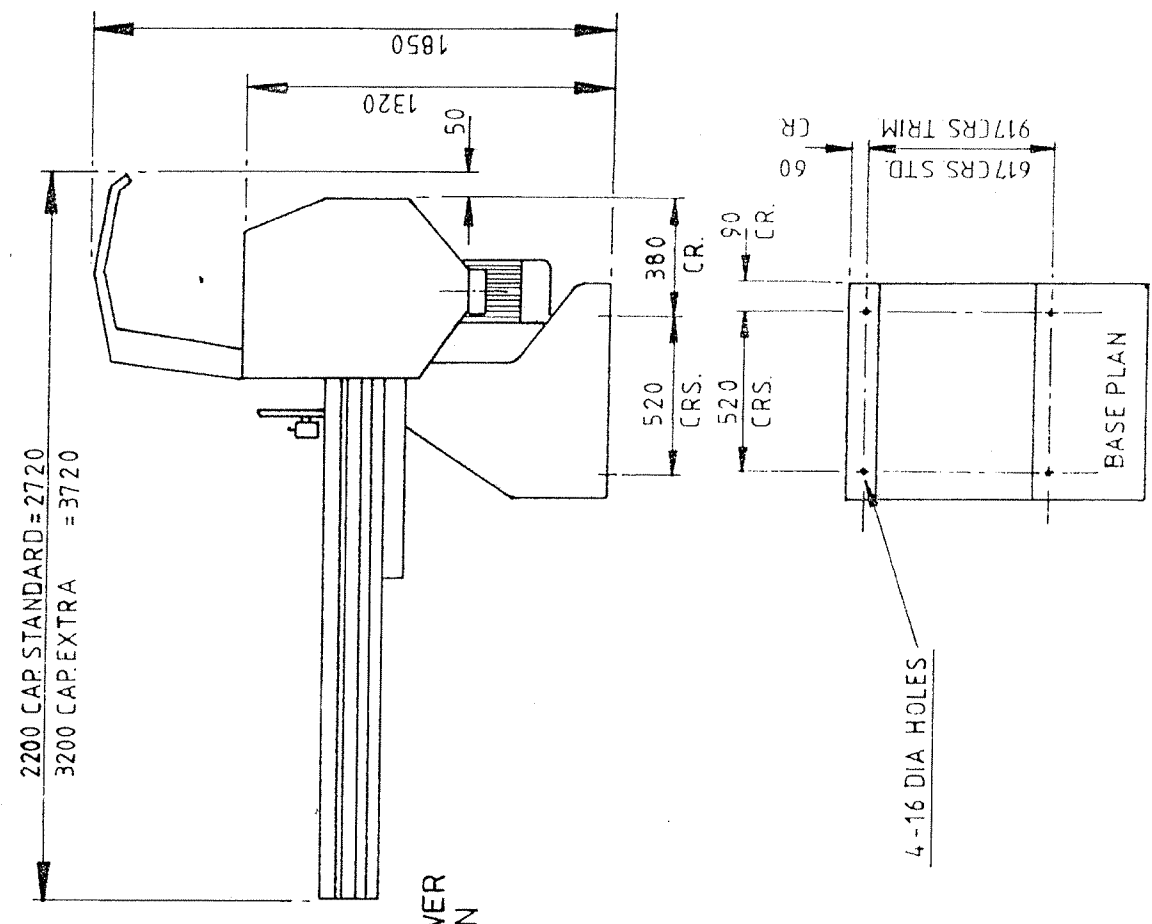

Fig 1

SPECIFICATION

Cutter Spindle Diameter	40mm	
Cutter Sleeve Diameter	60mm	
Usable Length of Sleeve	240mm	9.7/16 in
Maximum Tooling Diameter	300mm	12 in
NOTE: 320mm Diameter Tooling available with throwaway tipped cutters only		
Minimum Tooling Diameter	250mm	10 in
Maximum Timber Thickness	150mm	6 in
Maximum Timber Width (Each Table)	150mm	6 in
Maximum Length of Tenon	120mm	4 1/2 in
Vertical Movement of Tables	230mm	9 in
Horizontal Movement of Tables	25mm	1 in
Power of Cutter Motor	7.5kw	10 hp
Speed of Cutterhead 50 HZ	3000 rpm	
Speed of Cutterhead 60 HZ	3600 rpm	
Feed speeds (Cutting Stroke) 50 & 60 HZ	4 m/min	13 ft/min
(Return Stroke) 50 & 60 HZ	8 m/min	26 ft/min
Length of Fence Bars - Standard	1500 mm	5 ft
- Optional Extra	2200 mm	7 ft 6 in
- Optional Extra	3200 mm	10 ft 6 in
Floor space - standard	2150 x 2020mm	85 1/2 x 79 1/2 in
- optional	2150 x 2720mm	85 1/2 x 107 1/2 in
- optional	2150 x 3720mm	85 1/2 x 148 1/2 in
Approx. net weight of machine		
Approx. gross weight of machine		
Shipping dimension		



JET FOUNDATION PLAN

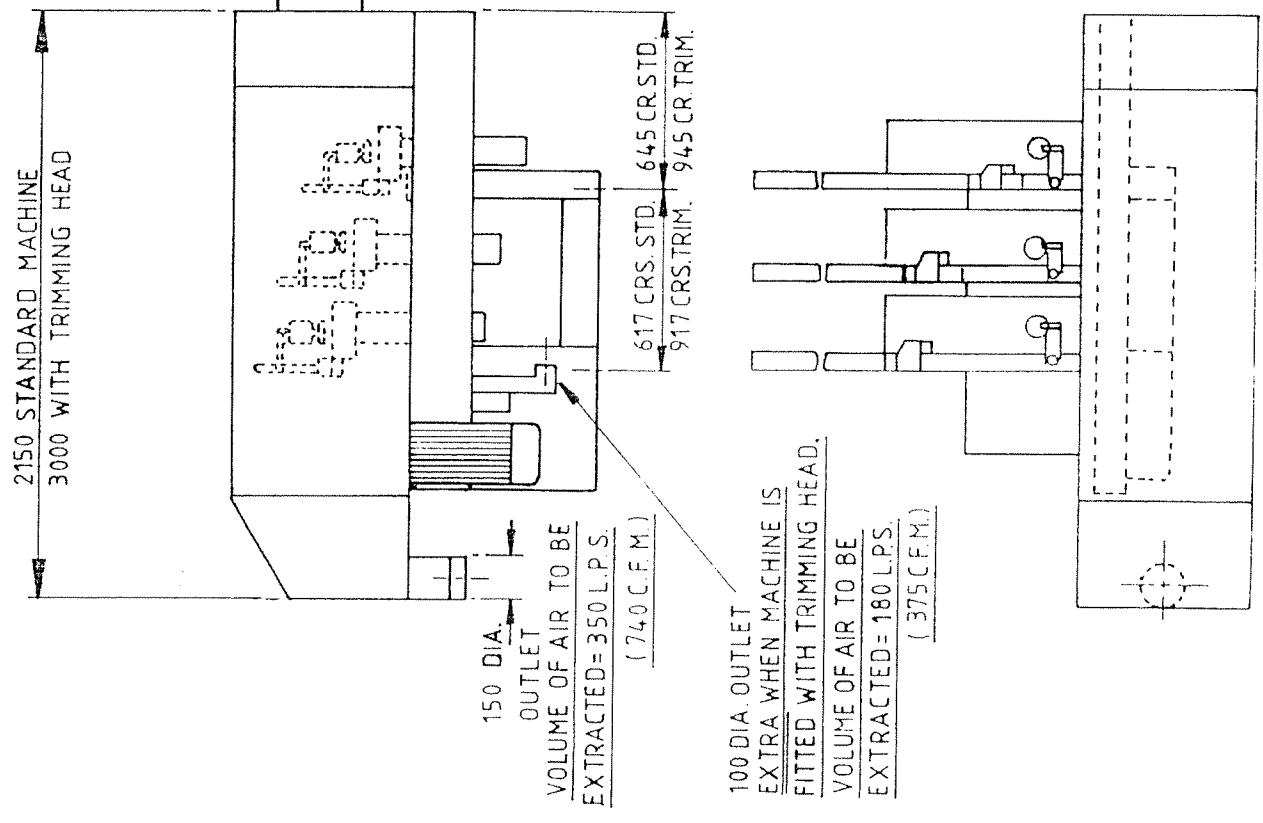

JET FOUNDATION PLAN

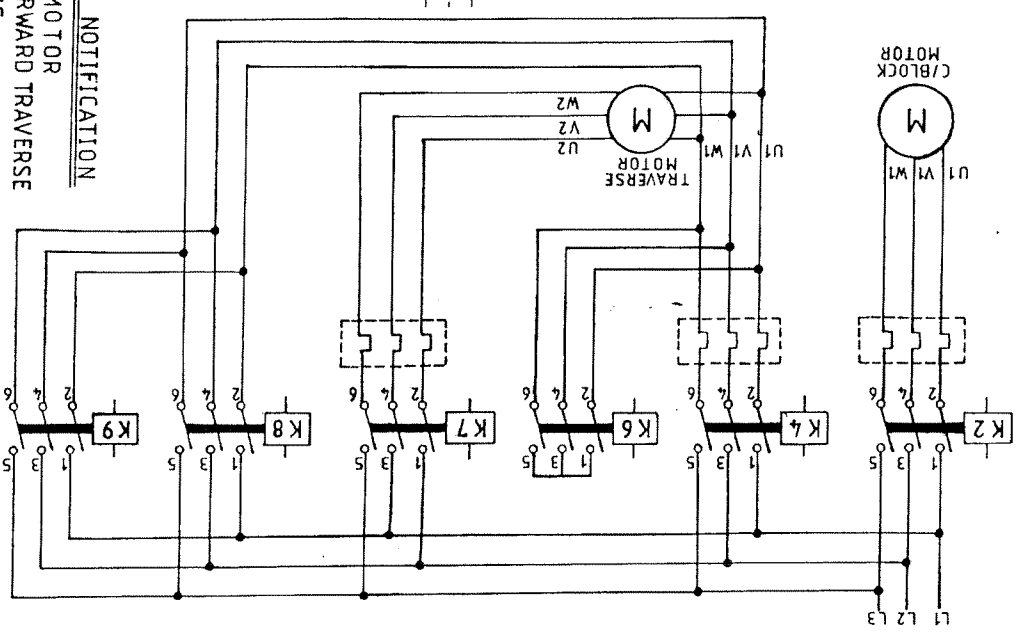

**CONTACTOR NOTIFICATION**

- K2 - BLOCK MOTOR
- K4 - SLOW FORWARD TRAVERSE
- K6 - BRIDGING
- K7 - FAST REVERSE TRAVERSE
- K8 - INCH FORWARD
- K9 - INCH REVERSE

THESE DIAGRAMS ARE GENERALISED FOR REFERENCE USE ONLY. REFER TO ELECTRICAL CIRCUIT DIAGRAM LOCATED IN ELECTRICAL CABINET FOR SPECIFIC INFORMATION.

**STANDARD WIRING DIAGRAM**

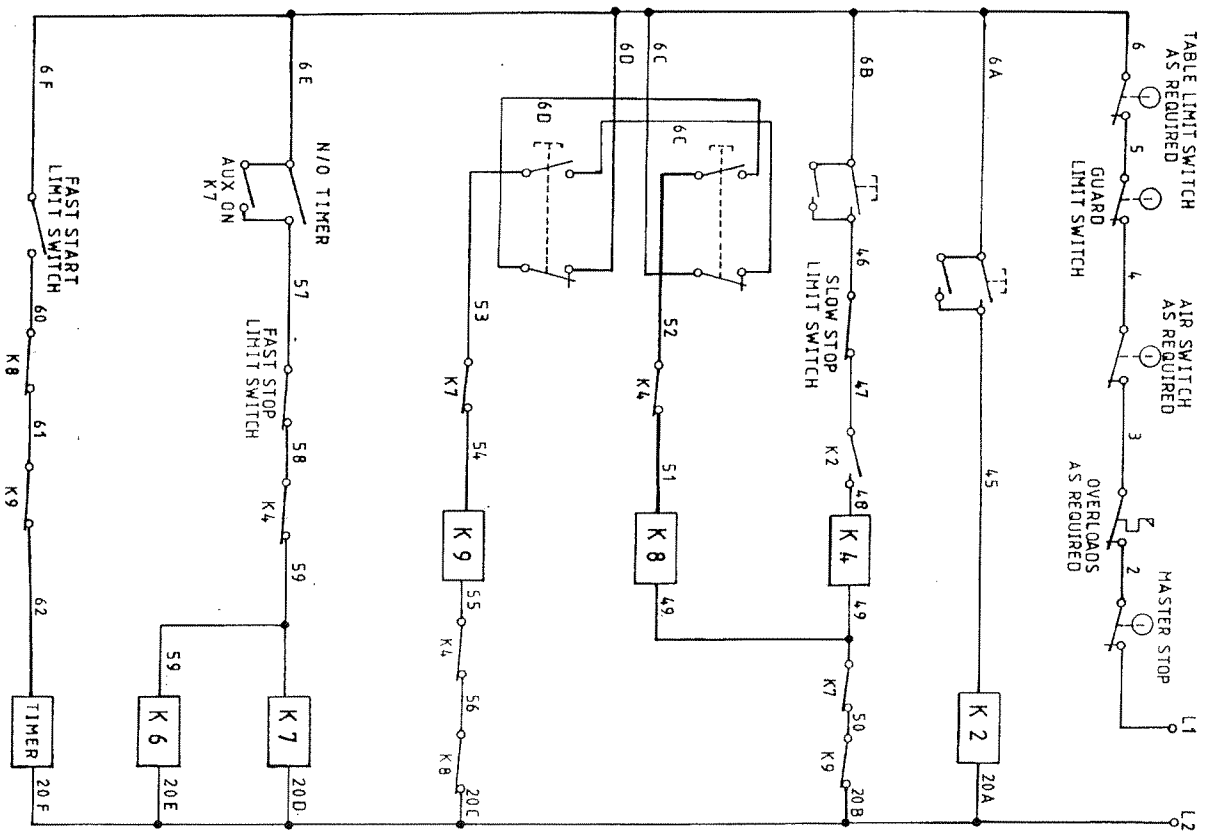

**Fig 3**



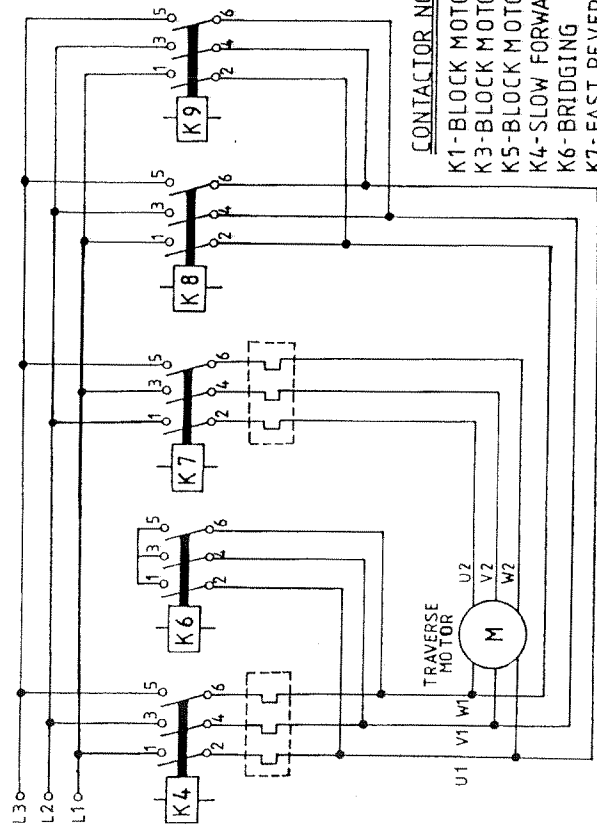
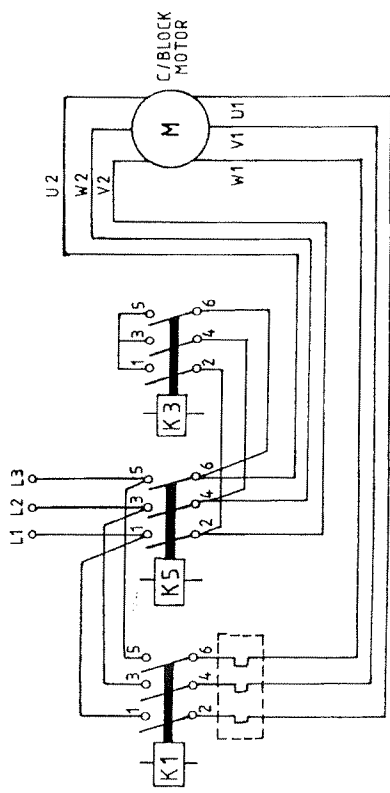

**CONTACTOR NOTIFICATION**

- K1-BLOCK MOTOR (MAIN)
- K3-BLOCK MOTOR (STAR)
- K5-BLOCK MOTOR (DELTA)
- K4-SLOW FORWARD TRAVERSE
- K6-BRIDGING
- K7-FAST REVERSE TRAVERSE
- K8-INCH FORWARD
- K9-INCH REVERSE

**STAR DELTA WIRING DIAGRAM**

THESE DIAGRAMS ARE GENERALISED FOR REFERENCE USE ONLY. REFER TO ELECTRICAL CIRCUIT DIAGRAM LOCATED IN ELECTRICAL CABINET FOR SPECIFIC INFORMATION.

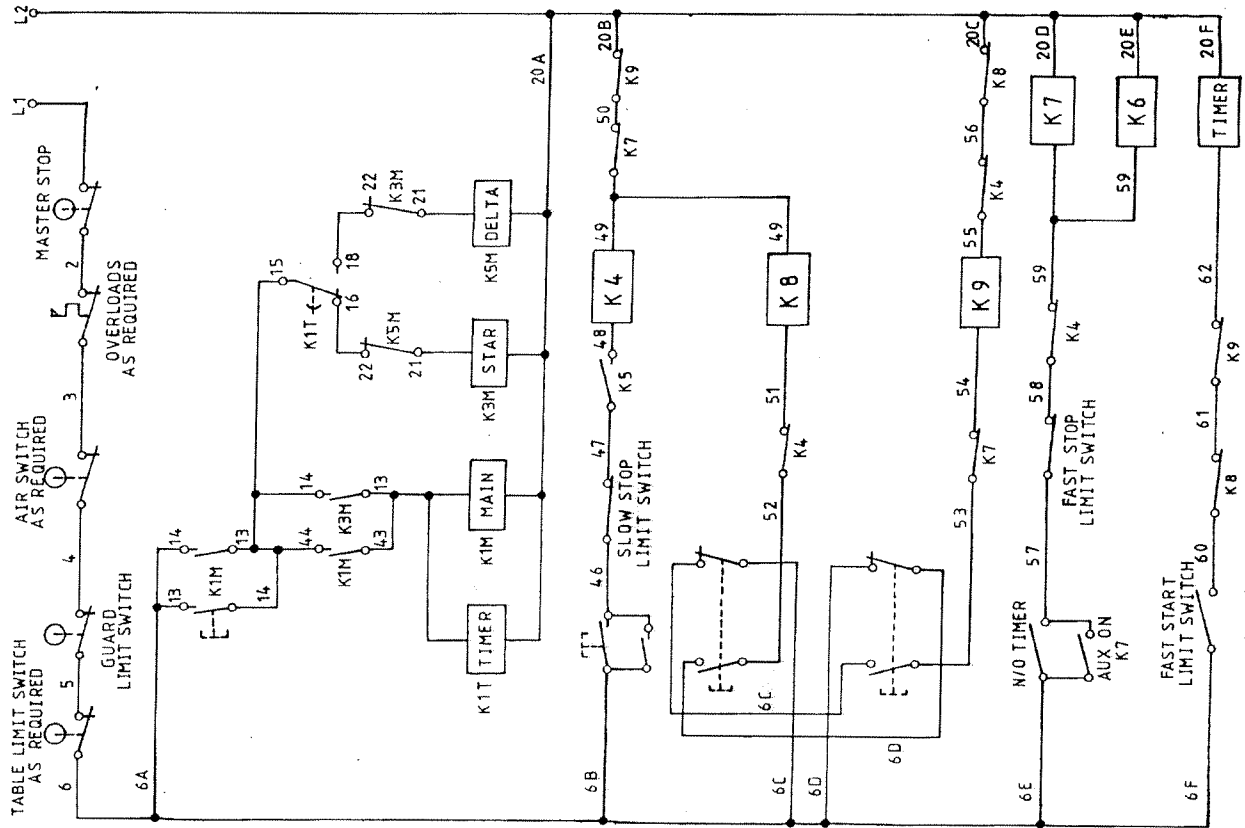

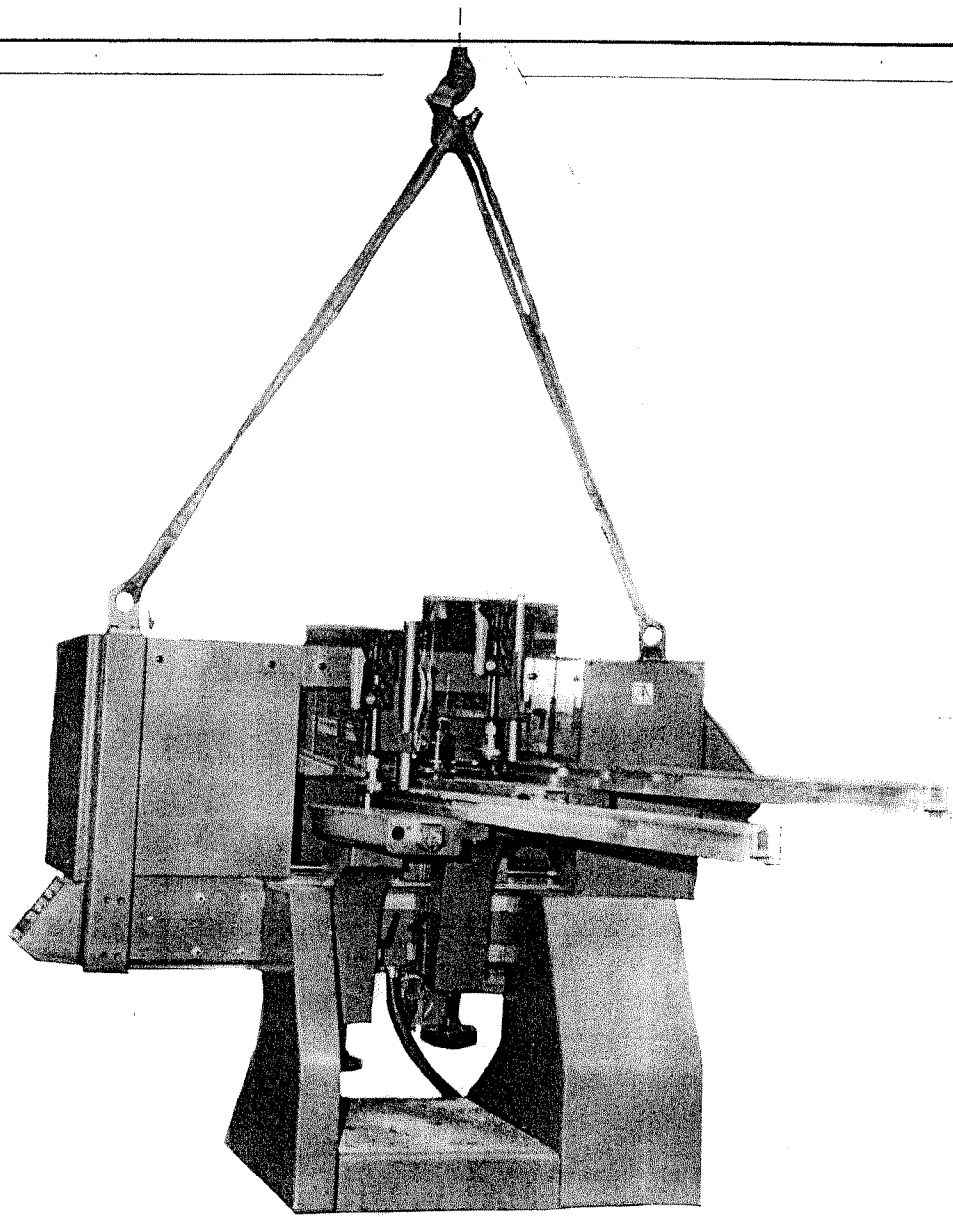

Fig5

DIAGRAM OF LEVELLING SCREW

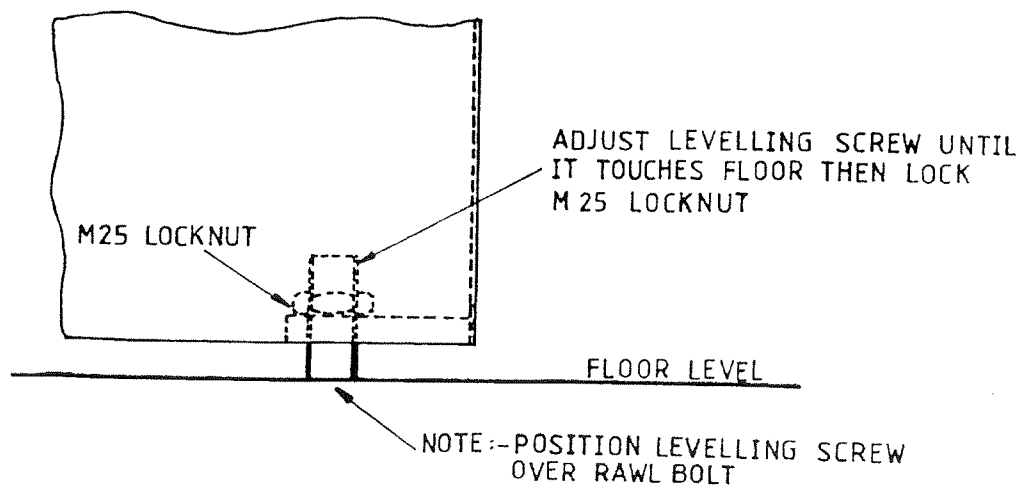

Fig6

## SLINGING

Always use a sling within safe working load of machine weight.

Approximate net weight of machine - KG  
 Approximate gross weight of machine - KG

Attach slings to lifting hooks in FIG.5 (return lifting hooks to WADKIN DURHAM for credit) ensuring damage will not be caused to machine during slinging operations.

**IMPORTANT: DO NOT WALK OR STAND UNDER MACHINE DURING SLINGING OPERATION.**

## INSTALLATION

Remove protective coating from bright parts by applying a cloth soaked in paraffin, turpentine or other solvent. Machine should be so placed that the traffic of men and materials to and from it fits smoothly into the general scheme of traffic. Machine should be so placed that it will not be necessary for the operator to stand in or near an aisle as to cause a hazard. The minimum clearance on each working side of machine should be at least 750mm greater than the length of the largest material worked on the machine.

## FOUNDATION

Ensure floor is level, then mark to suit 4 - M12 rawl bolts, refer to the foundation plan FIG.2. Drill floor to suit rawl bolts. These bolts are not supplied with the machine, but can be supplied at an additional charge. To obtain access to foundation bolts and levelling screw, remove plinth.

Position machine over rawl bolts and adjust levelling screw until it touches floor FIG.6. Fully tighten rawl bolts. Replace plinth.

## WIRING DETAILS

The motor and control gear have been wired in before despatch. All that is required is to connect the power supply to the starter or isolating switch when fitted.

Points to note when connecting power supply:-

- 1) Check the voltage, phase and frequency correspond to those on the motor plate, also the correct coils and heaters are fitted to the starter.
- 2) It is important that the correct cable is used to give the correct voltage to the starter as running on low voltage will damage the motor.
- 3) Check the main line fuses are of the correct capacity. See fuse list inside front cover of instruction manual.
- 4) Connect the line leads to the appropriate terminals. See wiring diagrams FIGS 3 & 4.
- 5) Check all connections are sound.

- 6) Check the rotation of all motors for the correct direction, if these are incorrect, reverse any two of the line lead connections.

#### ASSEMBLY OF MACHINE

-----

For ease of transportation the fences, clamps and stops are removed.

The fence is fitted to the rear of each table and is located in holes at inner and outer end of each table, secured by 2 - M10 hexagon head bolts.

Fit clamps to posts 'A' FIG.7 and turnover stops '' FIG.16 or shoulder stops '' FIG.17 to fence.

#### PREPARATION FOR OPERATION WHERE PNEUMATICS ARE FITTED

-----

The machine must be connected at point 'B' FIG.8 to a compressed 'air' supply.

This is for operation of clamps and shoulder stops.

Check the bottles 'C' to ensure that they have not been cracked or damaged during transit.

Check that oil is up to level mark 'D' and if necessary remove filler plug 'E' and top up using correct grade of oil. (See approved lubricants, Page).

Oil drip rate should be approximately 15 second intervals, pressure is regulated by knob 'F', adjust until a pressure of (5.7 kg/CM<sup>3</sup> (80 lbs/sq in)) is shown on gauge 'G'.

#### LUBRICATION

-----

The majority of machine working parts are designed to require no lubrication. All that is required is to oil the following weekly:-

- 1) Oil slideways, vertical and horizontal screw on all tables.
- 2) 2 shots of grease to ball screw through 2 grease nipples on carriage.
- 3) Top up pneumatic lubricator bottle (where fitted) through plug until oil reaches correct level shown by indicator mark on the side of bottle.

Approved lubricants, see page 25.

#### SAFETY DIRECTIVES

-----

Before starting machine it is essential to ensure that all cutters are tight and secure in the respective blocks and the latter are securely locked on the spindle.

Ensure that guard, clamps and stops are adjusted correctly before running cutterhead.

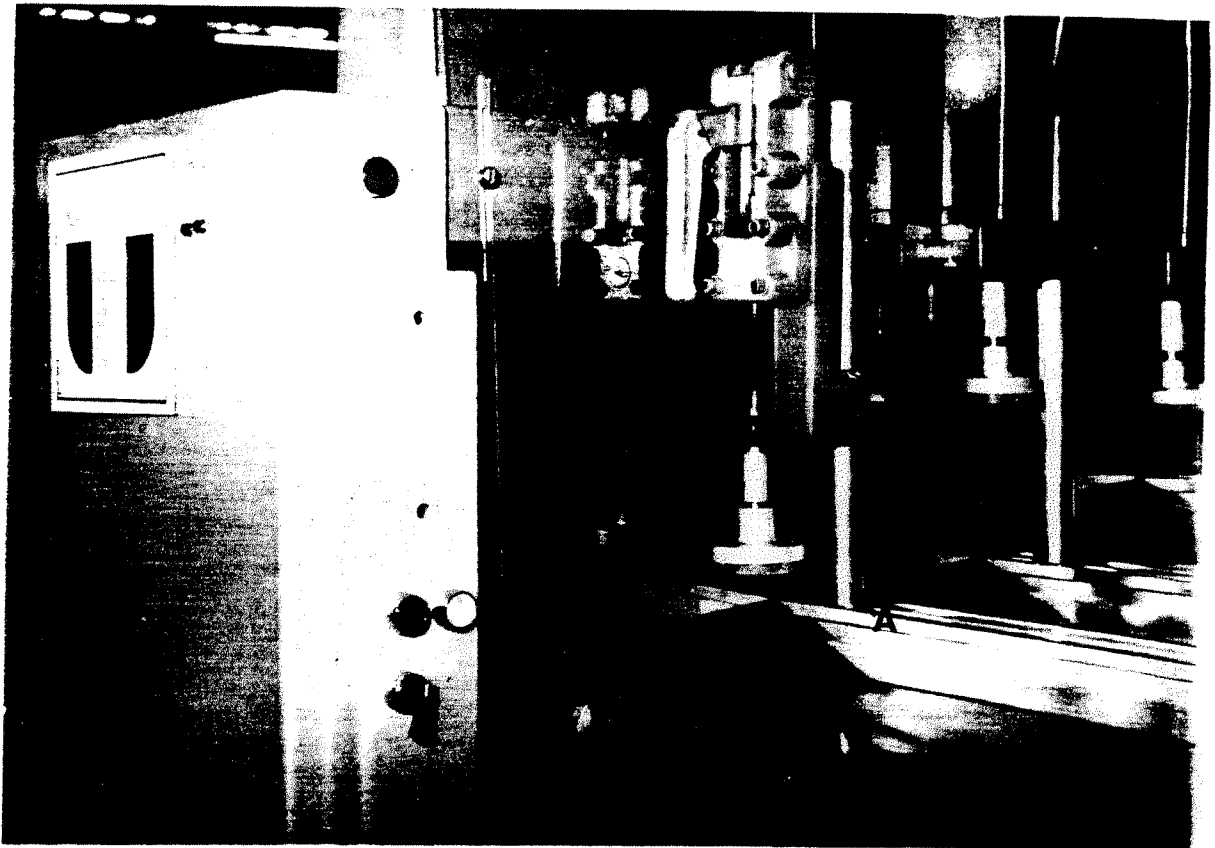

Fig 7

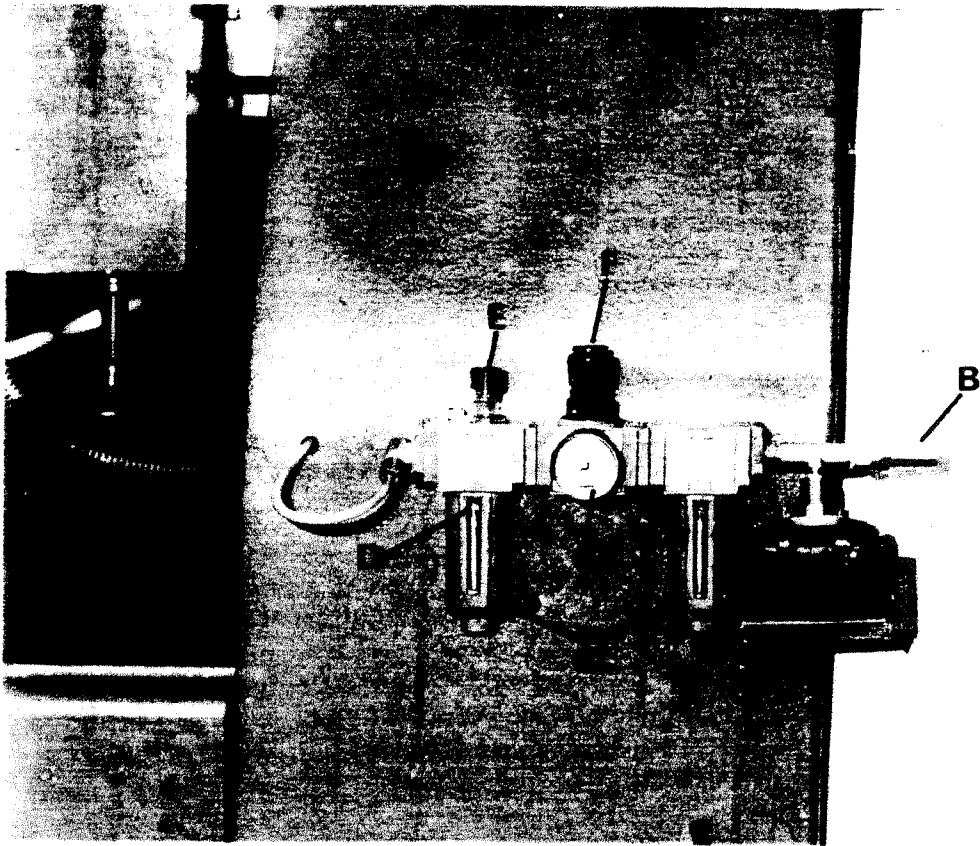

Fig 8

## START AND FEED CONTROL

---

Individual start and feed buttons FIG.9, are situated on front panel on beam.

When isolator (optional), which is situated on rear beam support, is fitted, proceed as follows:-

To start, turn isolator to '1', then press button 'H' FIG.9 to start cutterhead, then press feed button 'J'.

Where no isolator is fitted, control is simply via the panel start and feed buttons.

NOTE: HEAD MUST BE STARTED IN THIS SEQUENCE AND SHOULD BE LEFT RUNNING AFTER EACH CUT AS REPEATED STARTING AND STOPPING MAY CREATE EXCESSIVE HEAT IN THE MOTOR AND RAPID BRAKE WEAR.

## INCH FORWARD/INCH REVERSE CONTROL

---

For ease of tooling changes, inch forward/inch reverse buttons 'K' are situated on front panel on beam FIG.9.

## MASTER STOP CONTROL

---

A Master Stop button 'L' FIG.9, is situated on front panel on beam. Depression of Master Stop button shuts down all electrics. Master Stop button stays in the OFF position until released by pulling button.

## ADJUSTABLE STOPS

---

Two adjustable stops 'M' FIG.10 are fitted to rail 'N' and are positioned according to length of traverse required.

## FIXED STOPS

---

Fixed stops 'P' FIG.11 are fitted at either end of rail to safeguard overriding of adjustable stop when using inch forward/inch reverse.

## OVERSIZE TIMBER PRESSURE SWITCH

---

A pressure switch 'R' FIG.12 is situated on cutter guard 'S' and is actuated when an oversize piece of timber is clamped onto the machine. Once actuated the traverse is immediately stopped.

## VERTICAL ADJUSTMENT OF TABLE

---

Set each table vertically by loosening locking handle 'T' FIG.13 and position table by vertical adjustment handle 'U' in conjunction with digital readout 'V' FIG.12. Relock locking handle 'T'.

## HORIZONTAL ADJUSTMENT OF TABLE

---

Set each table horizontal by means of screw 'A' FIG.17.

## FRONT END STOP - STANDARD

---

To set tenon length use adjusting screw 'W' FIG.14. To set and stop 'X' FIG.15 use handle 'Y' FIG.14 and push through table and turn approximately 30° to locate on adjusting screw 'W'.

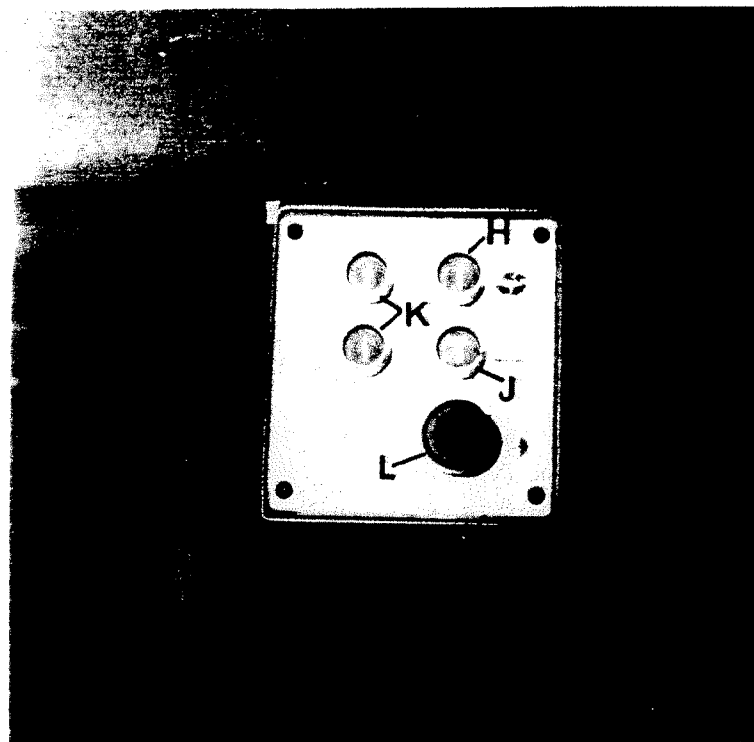

Fig 9



Fig 10

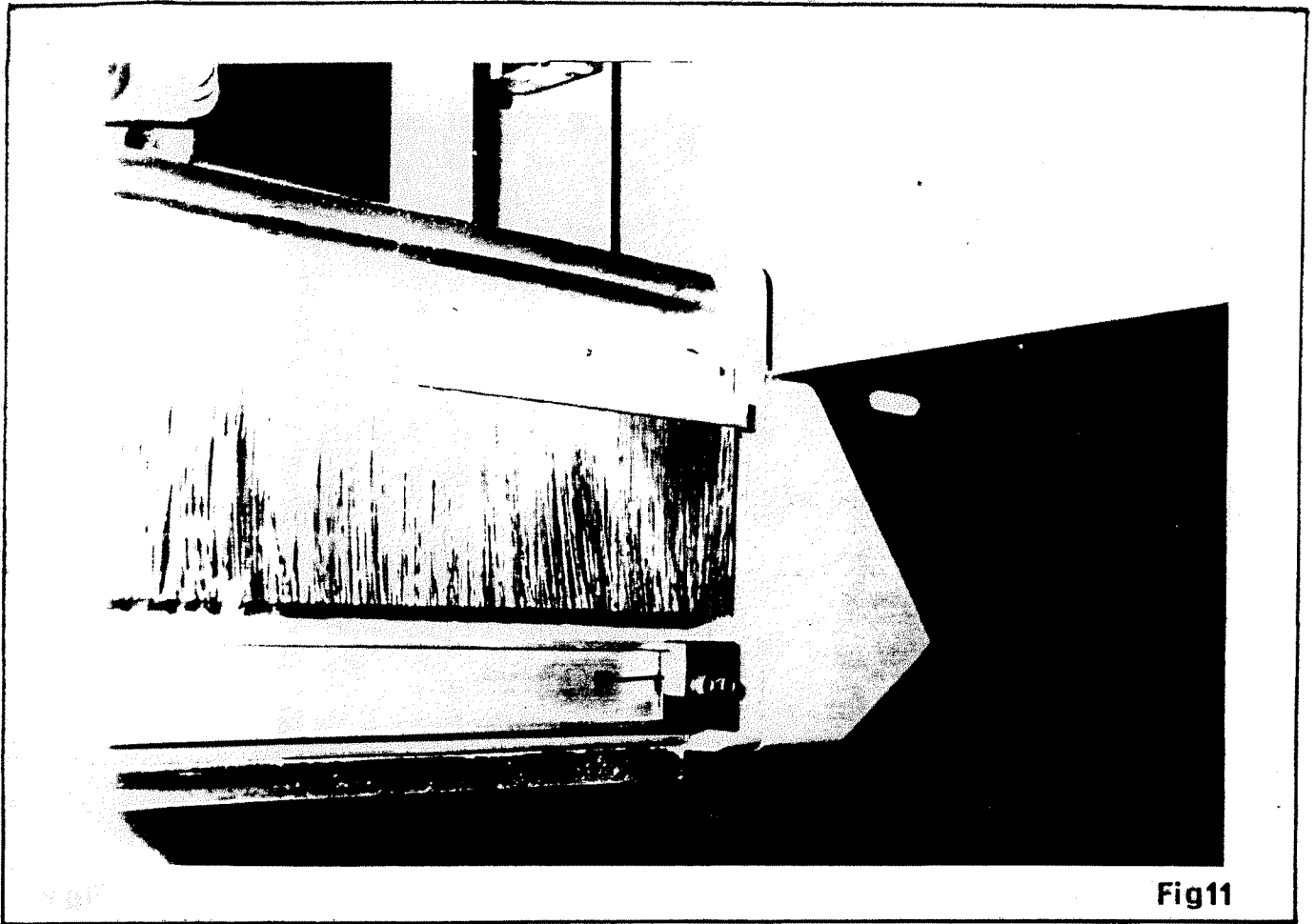

Fig11

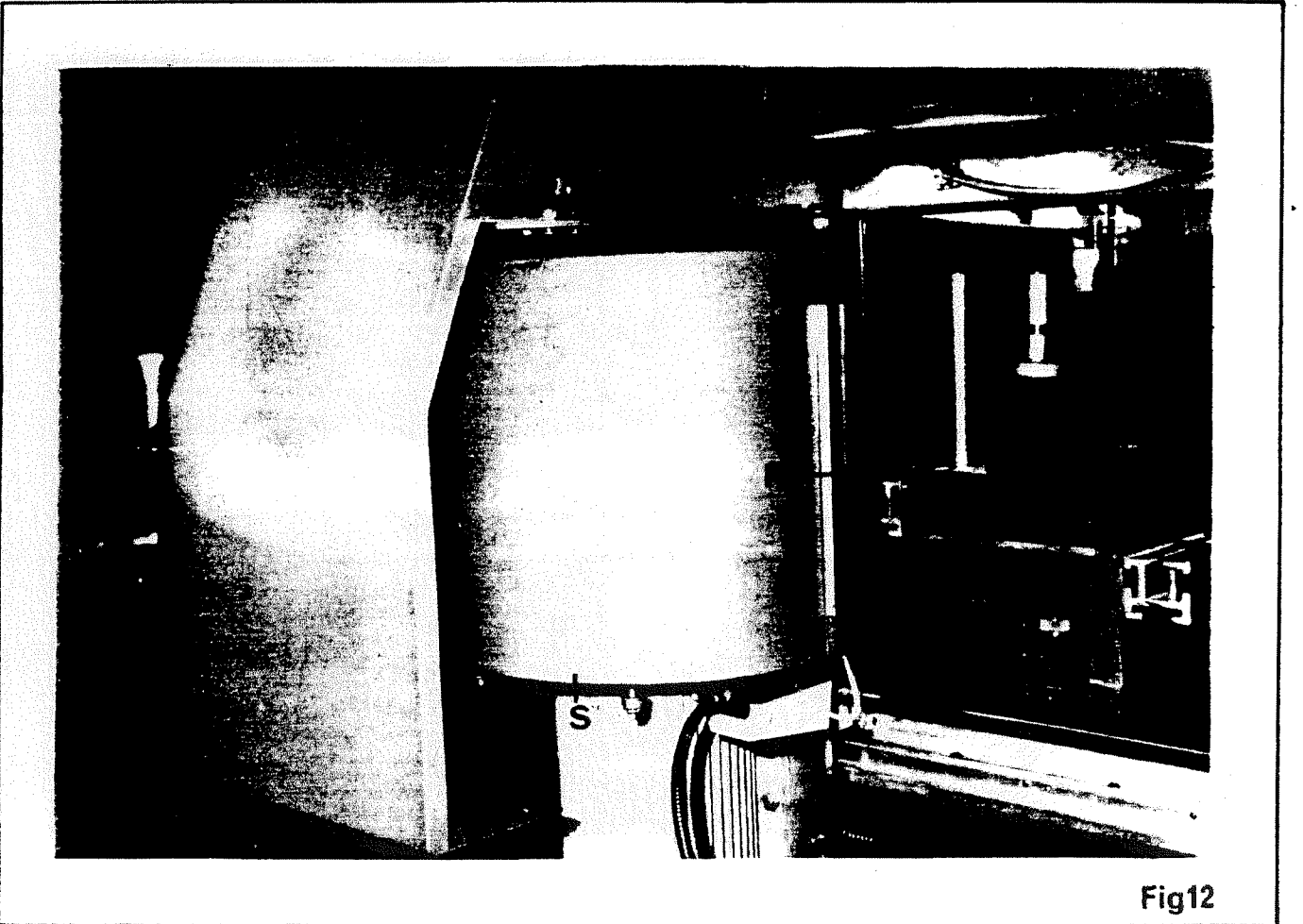

Fig12



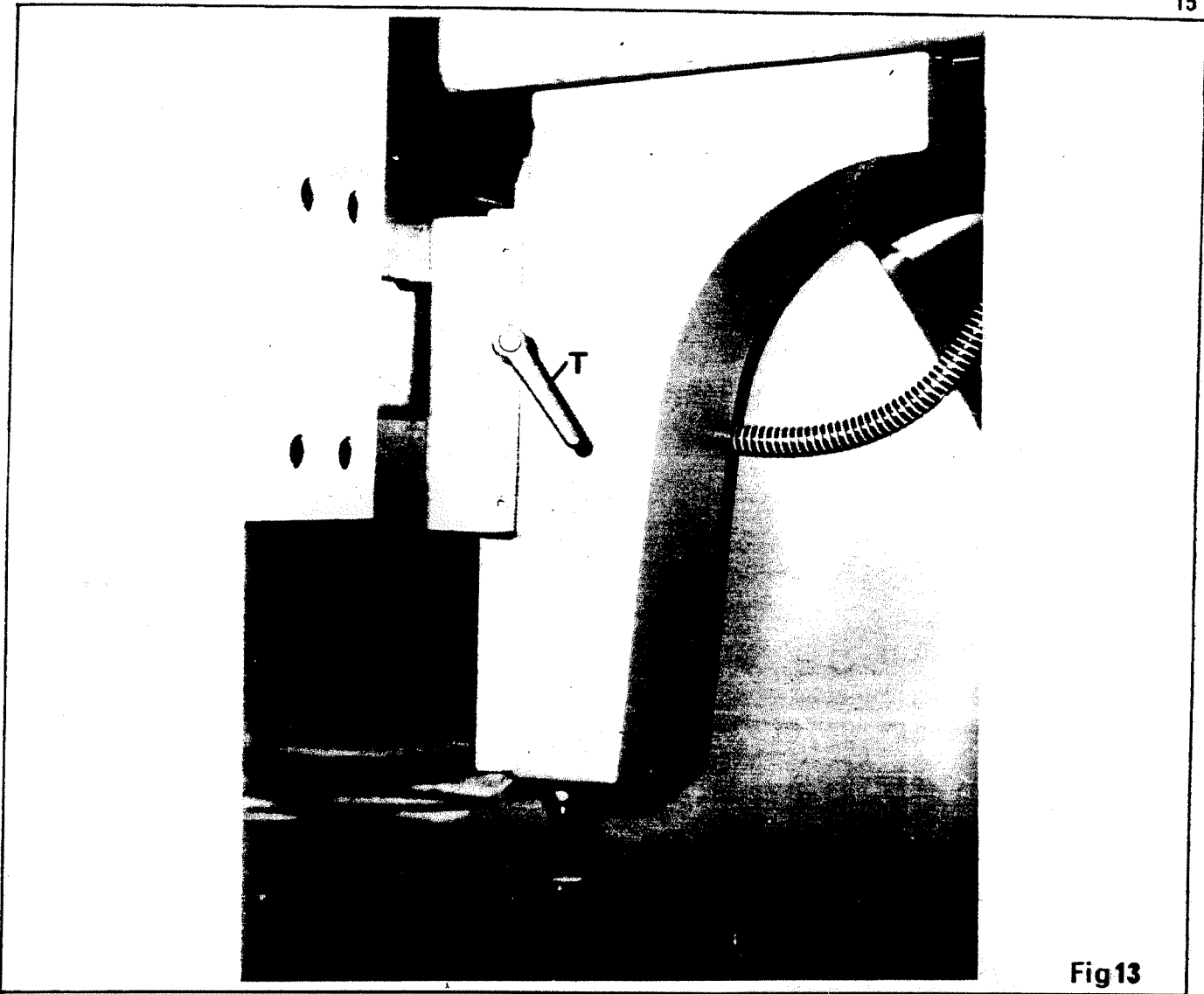

Fig 13

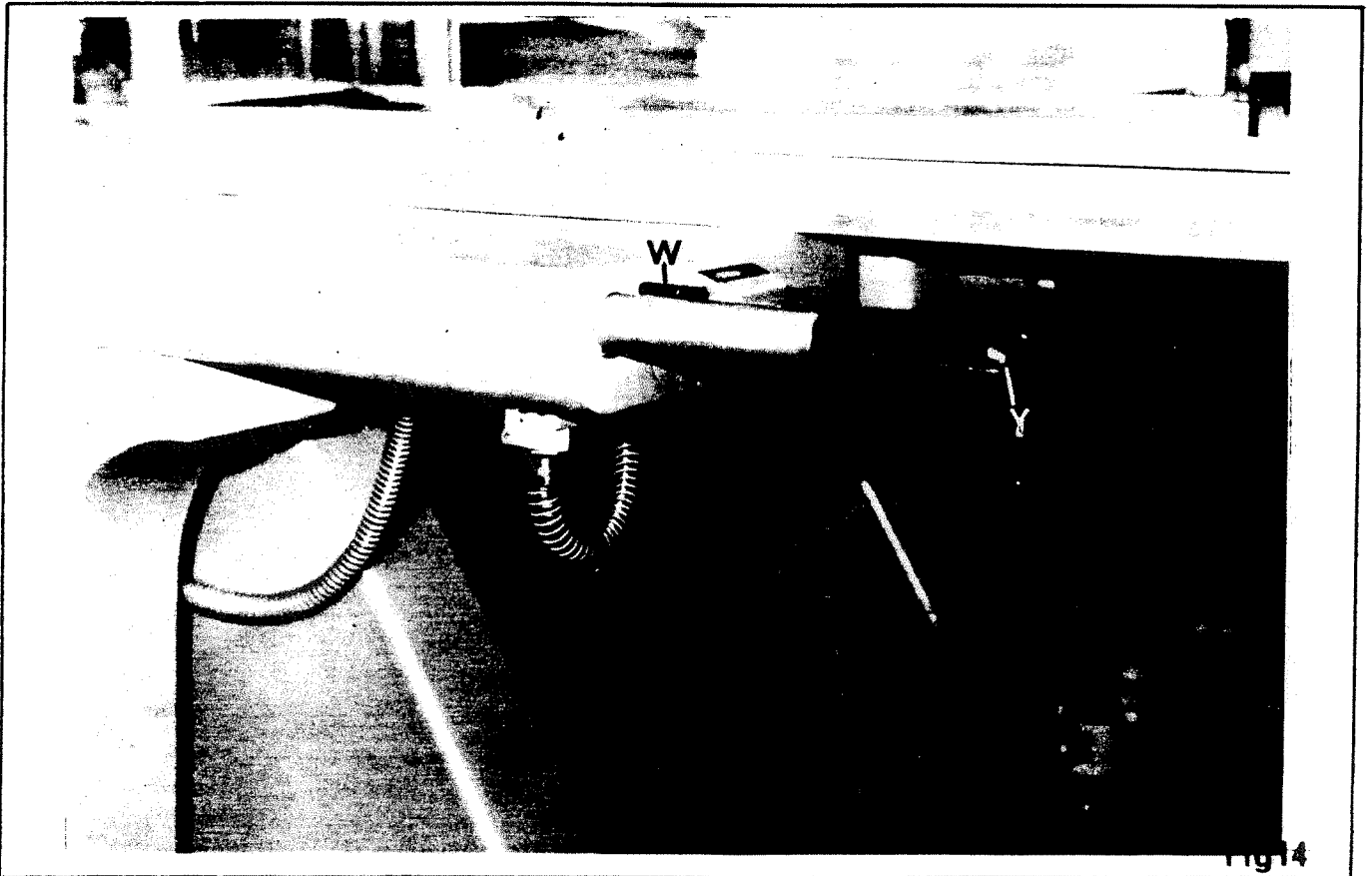

Fig 14

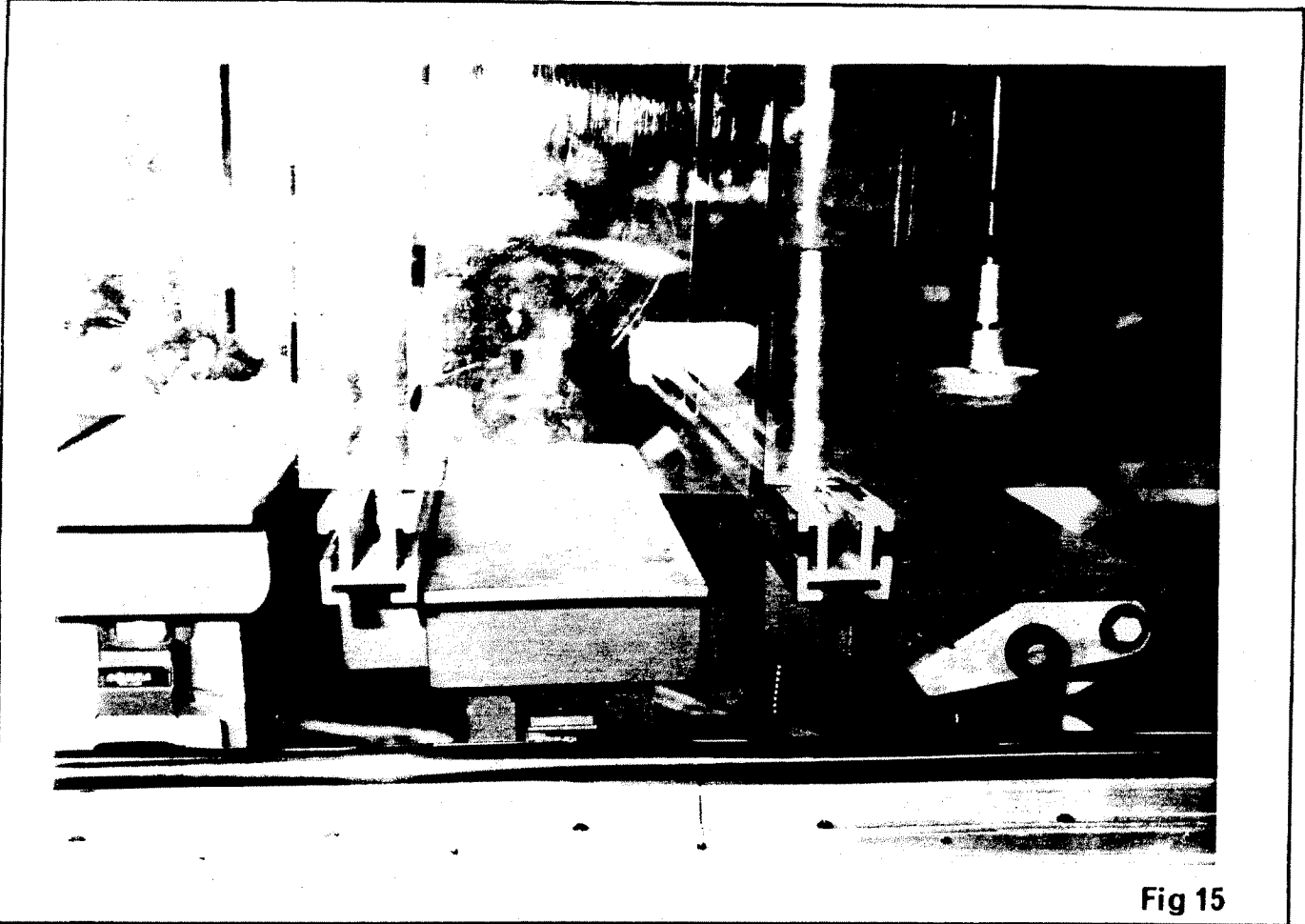

Fig 15

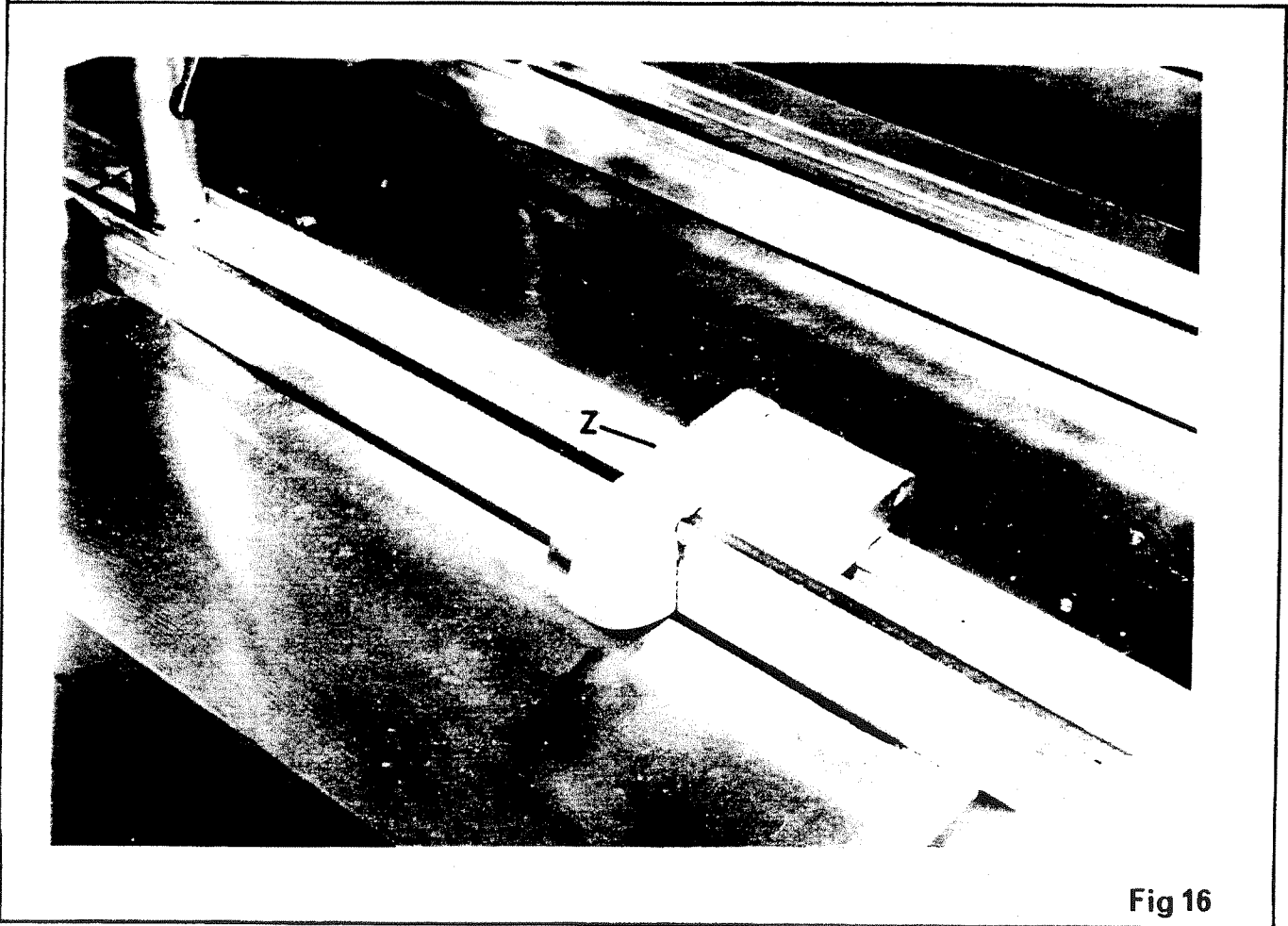

Fig 16

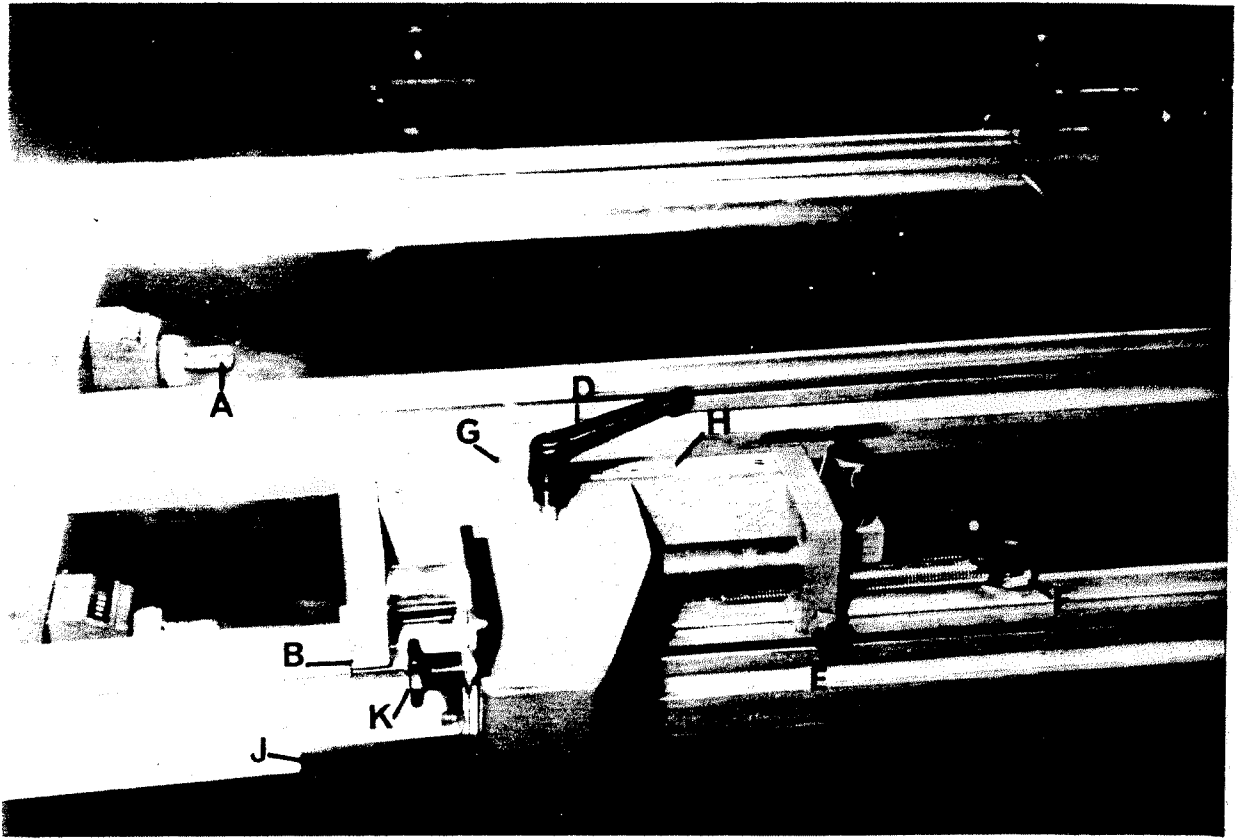

Fig 17

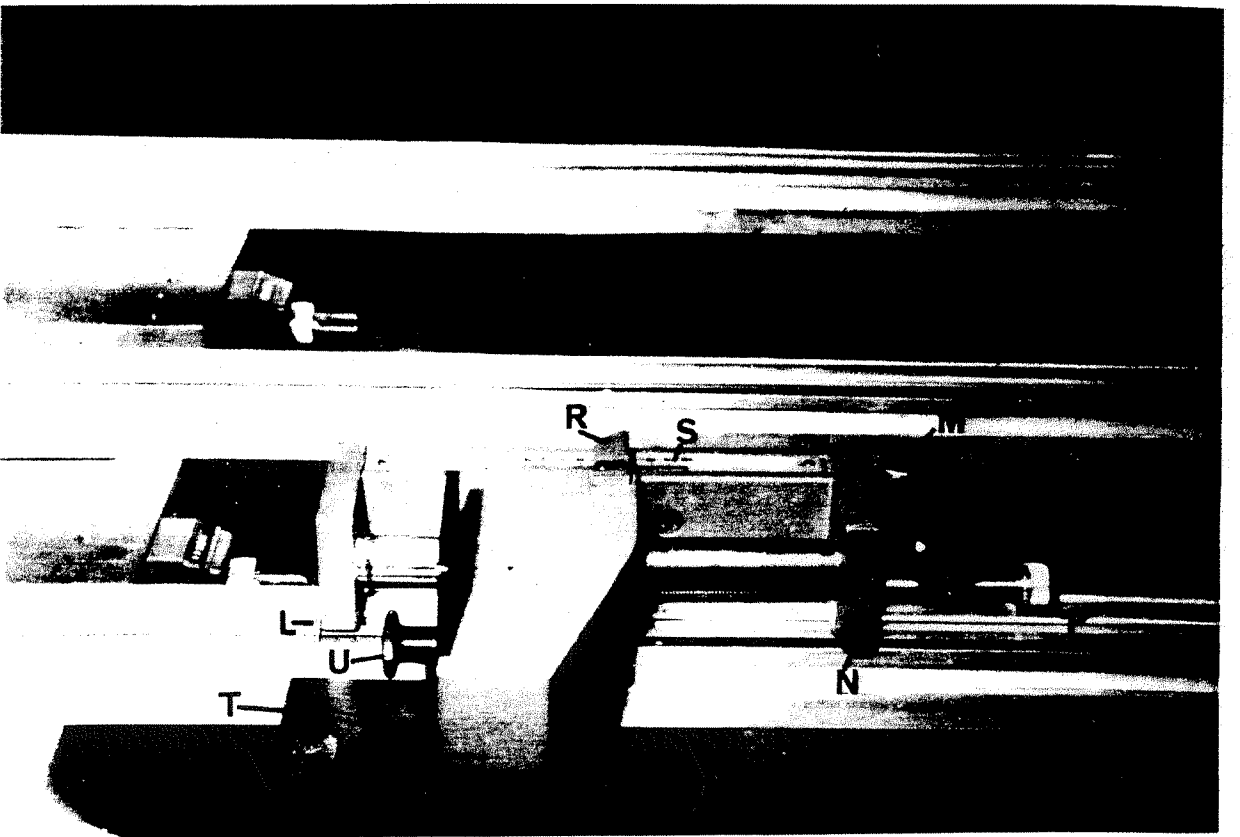

Fig 18

Clamp wood for first pass of timber.

NOTE: MACHINE WILL NOT TRAVERSE UNTIL END STOP IS WITHDRAWN.

Release clamps.

Turn timber for second pass and use either end stop or turnover stop 'Z' FIG.16.

#### MANUAL SHOULDER STOPS - EXTRA

-----

Set pointer 'B' FIG.17 on crosscut fence to shoulder distance by locking handle 'C'.

To set tenon length, loosen locking handle 'D' and locking screw 'E', adjust length with adjusting screw 'F' in conjunction with pointer 'G' and scale 'H'. Relock locking handle 'D' and locking screw 'E'.

Set shoulder height to suit with stop 'J' and locking knob 'K'.

Clamp wood for first pass of timber.

Release clamps.

Turn timber for second pass and move stop 'J' to shoulder distance. Clamp wood and continue with second pass of timber.

#### PNEUMATIC SHOULDER STOPS - EXTRA

-----

Set pointer 'L' FIG.18 on crosscut fence to should distance by locking handle 'M'.

To set tenon length loosen locking screw 'N' and adjust length with adjusting screw 'P' in conjunction with ppointer 'R' and scale 'S'. Relock locking screw 'N'.

Set shoulder height to suit with stop 'T' and locking knob 'U'.

Clamp wood for first pass of timber.

Release clamps.

Turn timber for second pass and move stop 'T' pneumatically to shoulder distance with toggle switch 'V' FIG.19.

#### MANUAL CLAMPS

-----

For vertical and swivel adjustment of clamps, loosen locking handle 'W' FIG.19 and adjust to required position. Relock locking handle 'W'.

For operation of clamp use handle 'X'.

For fine adjustment of pressure to clamp 'Y', loosen locking nut 'Z' and turn knurled 'A' to required pressure. Relock locking nut.

#### PNEUMATIC CLAMPS - EXTRA

-----

To operate pneumatic clamps press buttons 'B & C' FIG.19 simultaneously. To release clamps press ;buttons 'B' and 'D'.

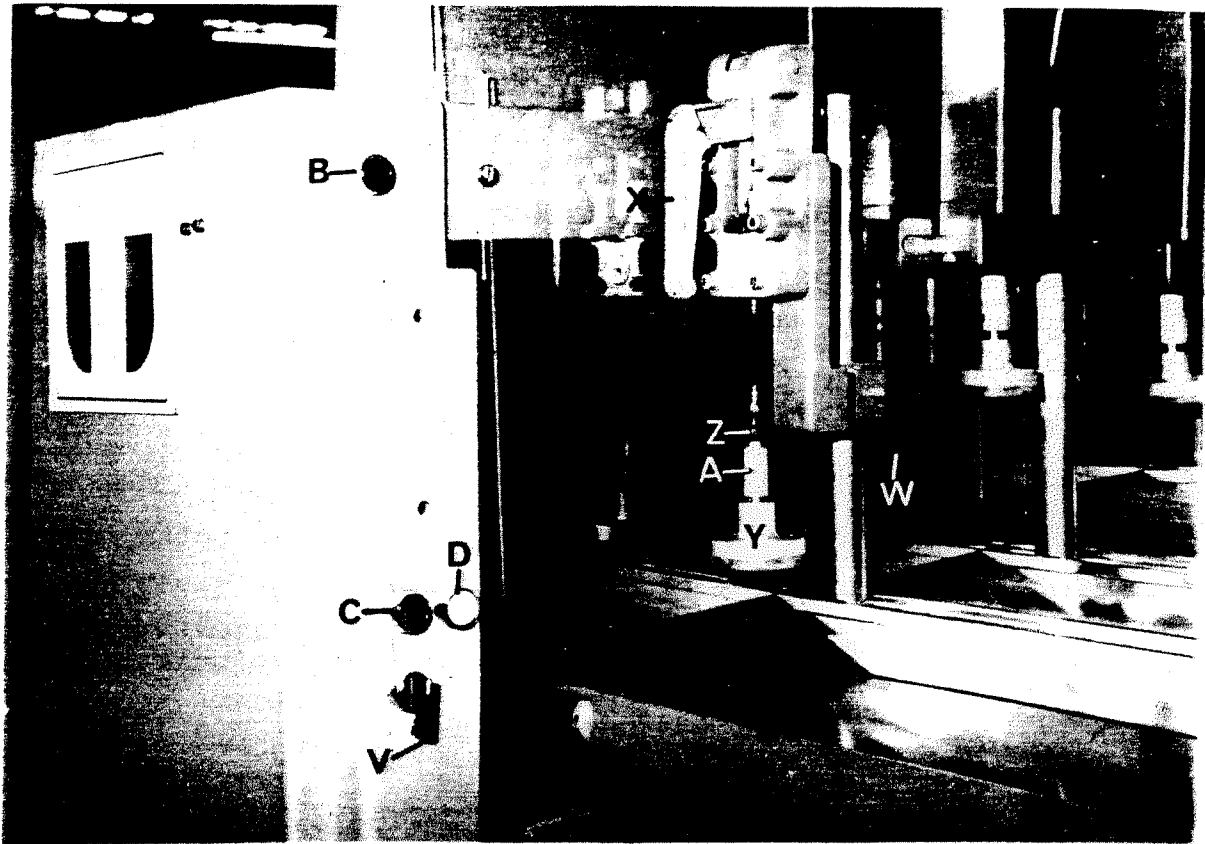

Fig 19

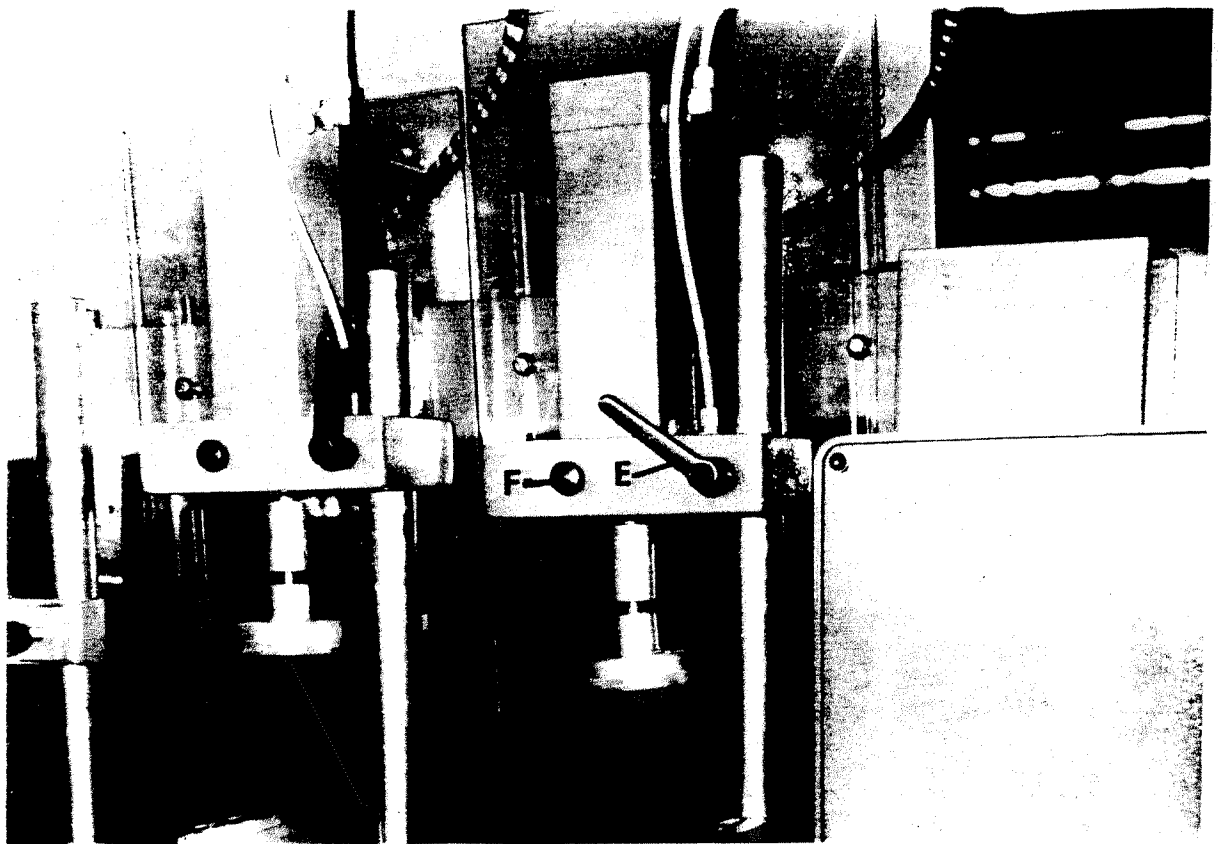

Fig 20

For vertical and swivel adjustment of clamps, loosen locking handle 'E' FIG.20 and adjust to required position. Relock locking handle 'E'.

For horizontal adjustment of clamps, loosen screw 'F' and adjust to required position. Relock screw 'F'.

NOTE: DIAGRAMS FOR PNEUMATIC SHOULDER STOPS AND PNEUMATIC CLAMPS ARE ON PAGES 22,

#### DRIVE BELT REPLACEMENT OR TENSIONING

---

Traverse of cutter head is through drive motor and belt to lead screw. To adjust belt or change, proceed as follows;

- 1) Isolate machine electrically.
- 2) Remove drive belt cover at rear of machine.
- 3) Release tension on pulleys by 4 - M10 hexagon head bolts 'G' FIG.21.
- 4) Position new belt over pulleys and tension belt by sliding plate 'H'. Correct tension will have been achieved when belt can be pulled 10mm in centre span.

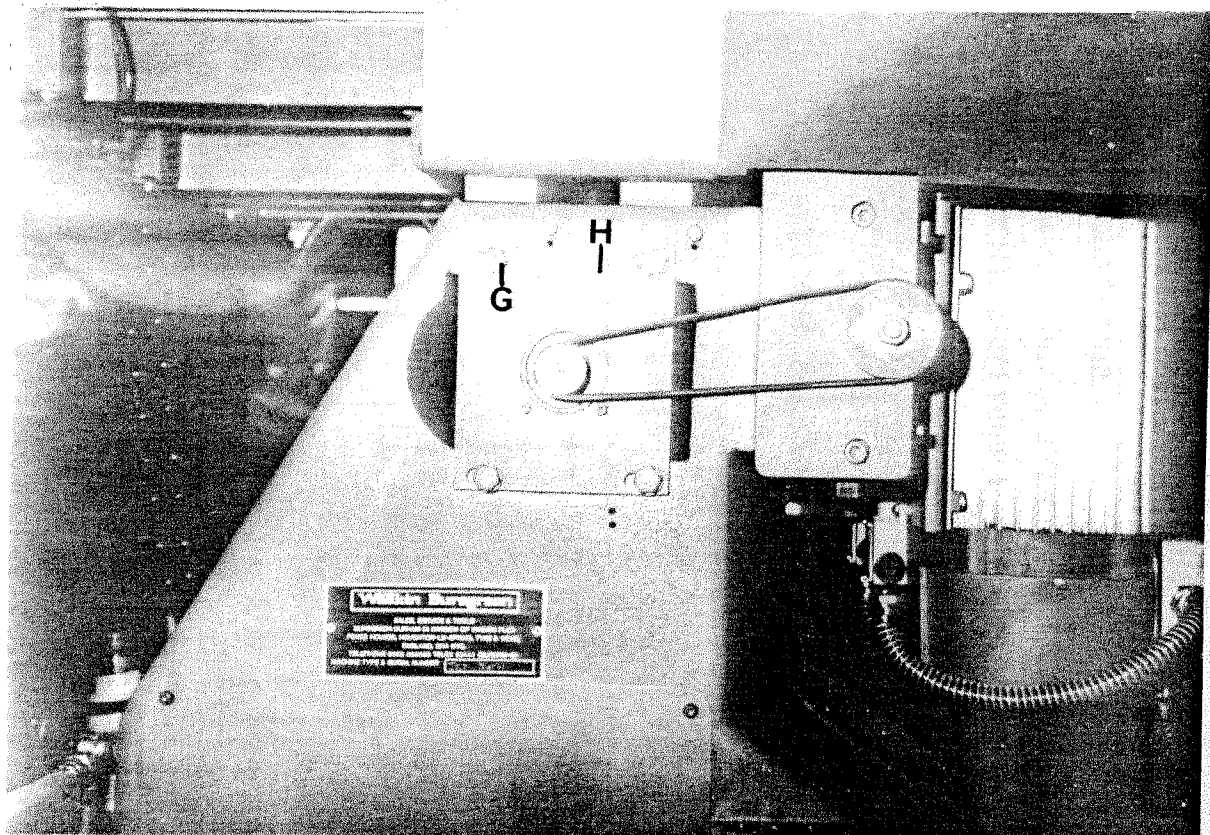

Fig 21

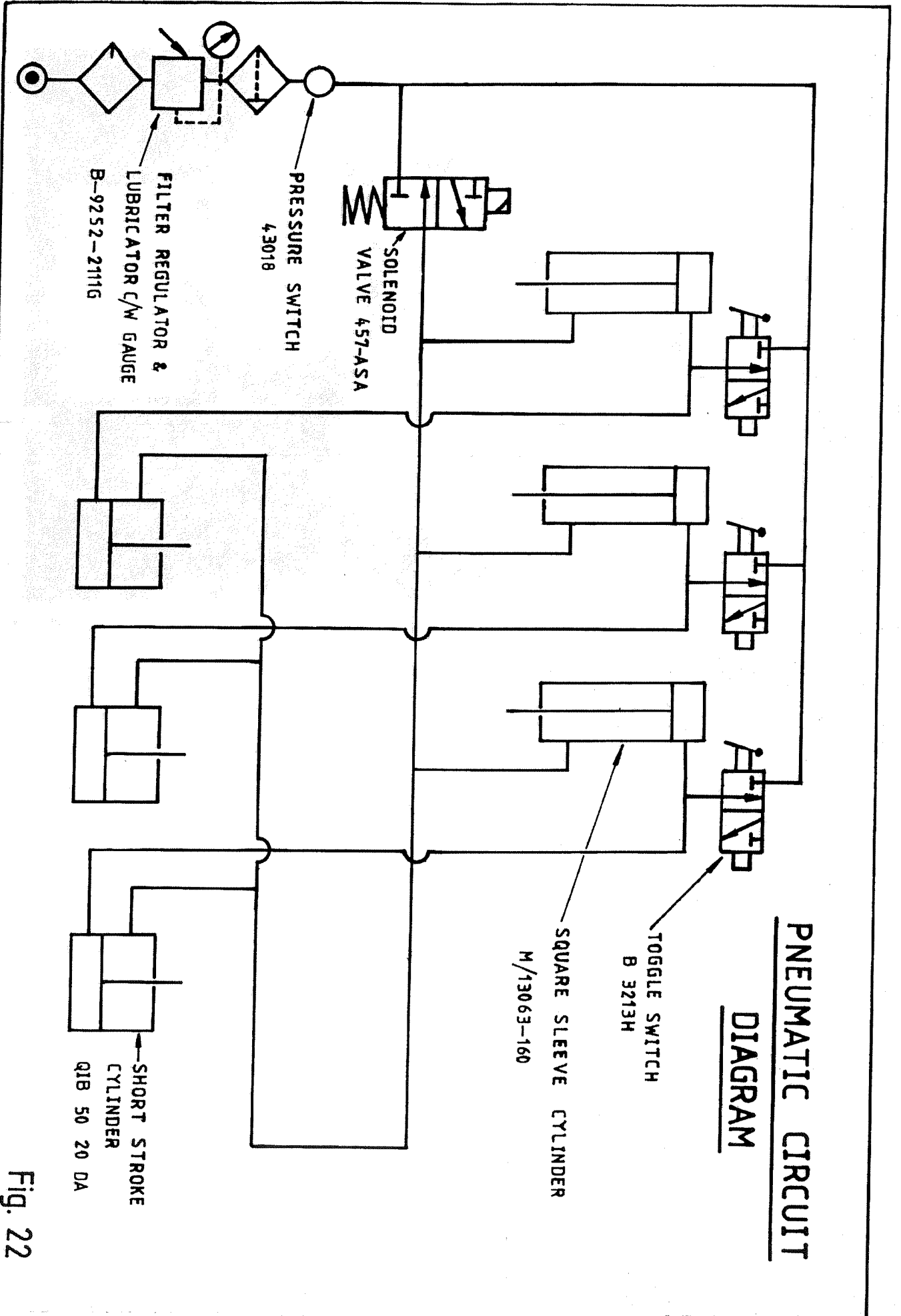

Fig. 22



A P P R O V E D L U B R I C A N T S						
Application	Castrol	B.P.	Shell	Esso	Texaco/Caltex	Wadkin
Worm Boxes	ZN220	Energol CS320	Vitrea 320	Spartan EP220	Regal Oil 320	L2
General Lubrication	Magna 68	Energol HP68	Vitrea 68	Nuray	Ursa Oil P68	L4
Pneumatic Lubricators	Hyspin AWS32	Energol HL32	Tellus 37	Nuto H32	Rando Oil HD32	
Grease	Spheerol AP3	Energrease L53	Alvania R3	Beacon 3	Regal Starfalk Premium 3	L6
Brake Cables	Brake Cable grease	Energrease L21M	Alvania R3	Esso Multi-purpose grease		