



ULTRACARE
At the Cutting Edge of Industry

EQ/EX

**VERTICAL SPINDLE
MOULDER**

OPERATING AND MAINTENANCE MANUAL

INCLUDING PARTS MANUAL

T: 0116 2769111

F: 0116 2598138

Wadkin

Single Vertical Spindle Moulder, Type E.Q. Double Vertical Spindle Moulder, Type E.X.

PRINCIPAL DIMENSIONS AND CAPACITIES:

	Single Machine							Double Machines	
	E.Q.							E.X.1	E.X.2
Net weight in cwts.	12							26	23
Length of table	3' 0"							6' 6"	5' 6"
Width of table	2' 8"							3' 0"	3' 0"
Height of table	2' 9"							2' 9"	2' 9"
Maximum vertical traverse of spindle	6"							6"	6"
Distance between spindle centre lines (EX machine only)	—							3' 6"	2' 6"
	R.P.M. ON 50							R.P.M. ON 60	
	CYCLES							CYCLES	
Standard motor is 5 H.P. at	2,840							3,400	
Speeds of cutter spindle	6,000 & 4,500							7,200 & 5,400	
Alternative cutter spindle speeds	6,000 & 3,000							7,200 & 3,600	
	4,500 & 3,000							5,400 & 3,600	
	7,500 & 5,000							9,000 & 6,000	
	9,000 & 6,000							—	
	9,000 & 4,500							—	
Speeds of motor on four-speed machine	2,840 & 1,420							3,400 & 1,700	
Cutter spindle speeds on four-speed machine	9,000 4,500							9,000 4,500	
	6,000 3,000							6,000 3,000	
Alternative	6,000 3,000							6,000 3,000	
	4,500 2,250							4,500 2,250	

With all communications please quote machine number and test number from the machine nameplate.

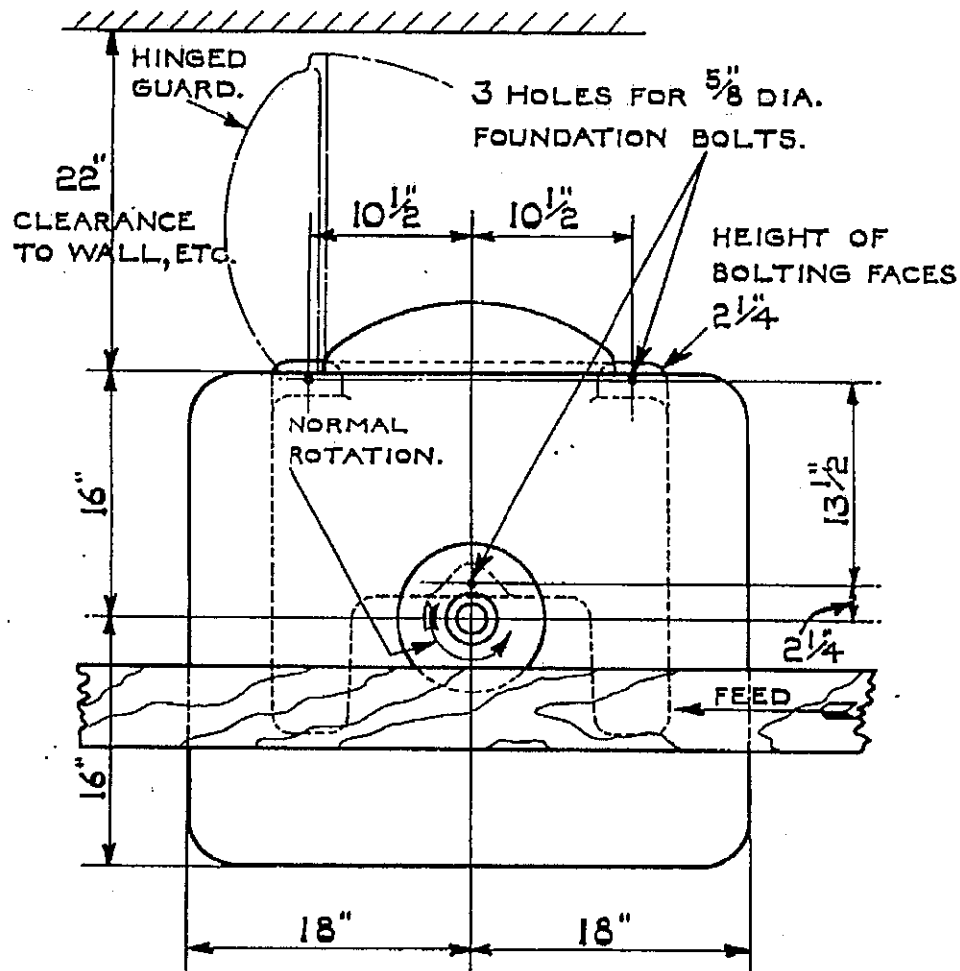

FIG. 1. PLAN OF SINGLE SPINDLE MOULDER TYPE EQ.

FOR EQUIPMENT INCLUDED WITH THE MACHINE
SEE PAGE 3.

INSTALLATION

(See Fig. 1 for Single machine and Fig. 2 for Double machine)

The machine is despatched from the Works with all bright surfaces greased to prevent rusting. This must be removed by the application of paraffin or turpentine.

FOUNDATIONS

$\frac{5}{8}$ " (16 m/m) dia. bolts should be used to fix the machine to the floor, but these are not supplied by Wadkin Ltd. unless specially ordered.

If mill floor consists of concrete, no special foundation is necessary and rag bolts or plates and bolts may be used: cut 4" (100 m/m) square holes in the concrete and run with cement to fix. Alternatively, rawl plugs may be used.

A good wood floor is satisfactory and coach-screws may then be used.

Carefully level the table before final fixing.

WIRING

If the machine has not been ordered with a triple pole isolating switch, make sure that one is fitted adjacent to the machine, to enable the electrical gear to be readily isolated for wiring and inspection purposes.

The mains entry is shown in Fig. 4, and the three main wires must be connected to the terminals L1, L2, L3, respectively, as shown on the wiring diagram, page 11.

The spindle(s) are designed to revolve in the direction shown in Fig. 1 or Fig. 2. If they do not, interchange any two of the connections on the terminals.

Also connect the machine to earth from the terminal provided.

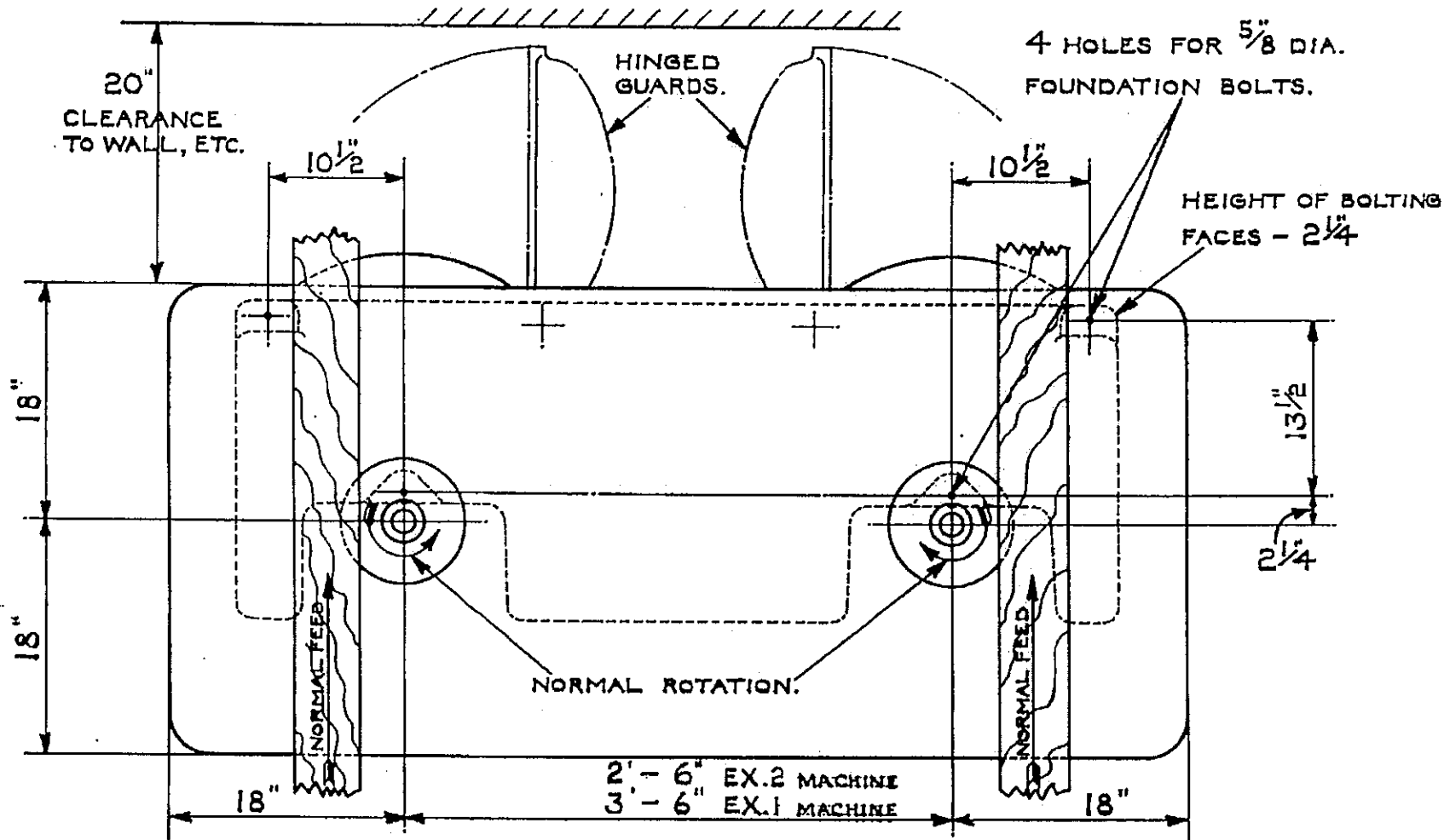

FIG. 2. PLAN OF DOUBLE SPINDLE MOULDERS TYPE EX.

EQUIPMENT INCLUDED WITH STANDARD MACHINES

Note : In the case of the Double Type Machine the appropriate items are duplicated.

5 H.P. motor complete with suitable control gear.

1 1/4" diameter loose top piece.

Grooved cutter collars.

Set of spacing collars.

Independent adjustable fences with top and side spring pressures.

4' long square cutterblock with bolts and washers.

(Note : This item is not supplied with Double Spindle machines and with machines running at speeds of 9,000/6,000 r.p.m. or 9,000/4,500 r.p.m.).

Set of spanners.

Lubricating pump and tin of ball bearing lubricant.

CONTACTOR PANEL ON
THIS SIDE OF BODY.
AND ISOLATING SWITCH
(IF ORDERED)

LUBRICATION POINT A.
CUTTER SPINDLE BEARINGS.

PUSH BUTTON
CONTROLS.

SPINDLE BRAKE
LEVER.

LOCK FOR RISE AND
FALL MOTION

SPINDLE LOCK LEVER
FOR USE WHEN
CHANGING CUTTERS.
(OPERATE ONLY WHEN
SPINDLE IS STATIONARY.)

LUBRICATION POINT B.
HANDWHEEL SHAFT

HANDWHEEL FOR RISE
AND FALL OF SPINDLE.
(WHEN TRAVERSING 1" OR MORE
KEEP BELT IN ALIGNMENT BY
RUNNING THE SPINDLE OR
SPINNING IT BY HAND).

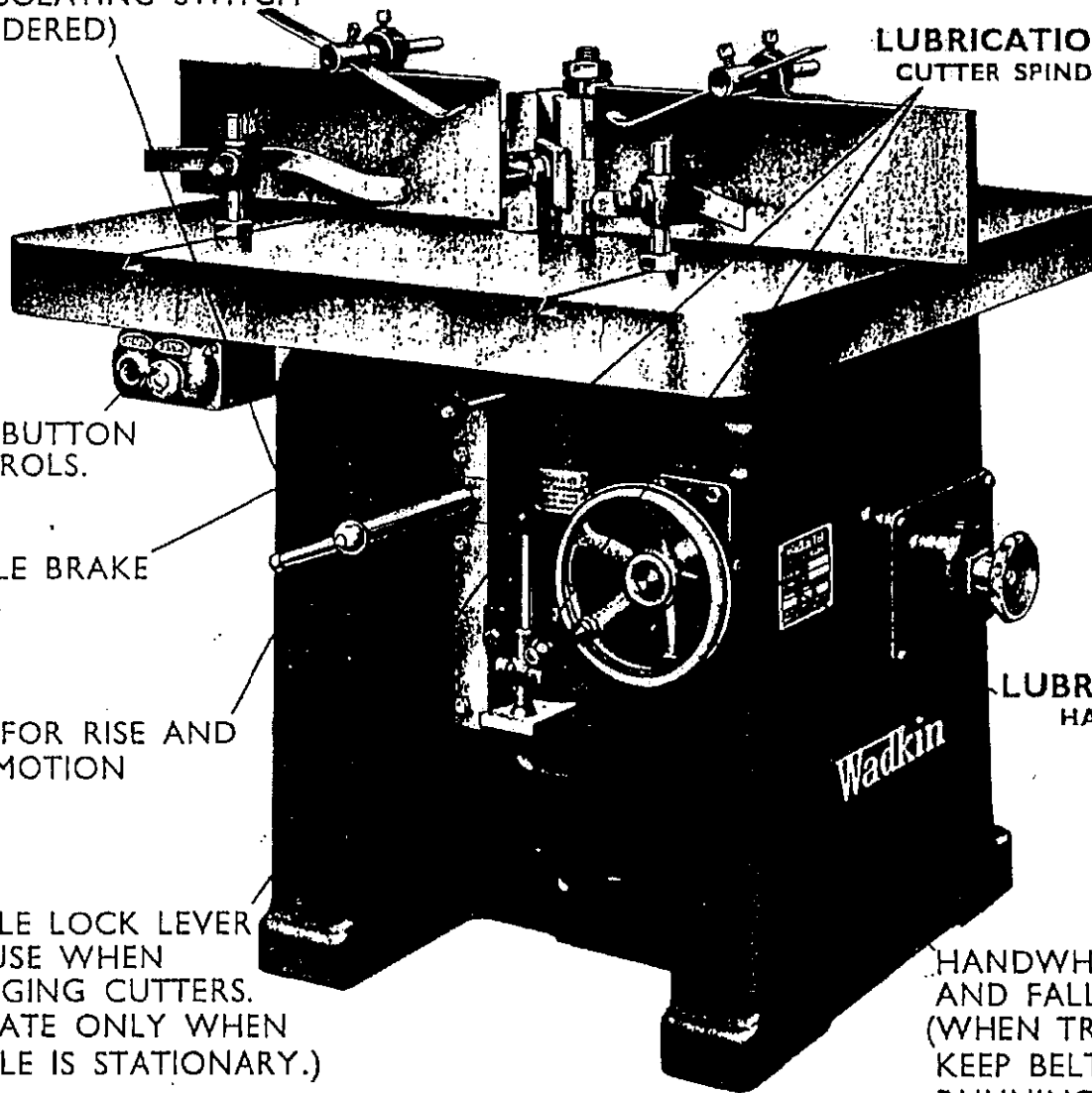

FIG. 3. FRONT VIEW OF SINGLE MACHINE E.Q.

(All controls are duplicated on EX machine).

LUBRICATION (see Figs. 3 and 4)

The only lubricator necessary is an oil gun. A grease gun is not required.

Keep the machine in good condition by maintaining a thin film of oil on the slide and on all bright parts not in constant use.

- A. 2 POINTS.** Every day give one depression of the oil gun using Wadkin oil, Grade L.1.
 - B. 4 POINTS.** Oil monthly using oil gun.
 - C. 2 POINTS.** Every 3 months give five complete turns to the small grease cups using Wadkin grease, Grade L.6.
- NOTE: A "protected type" motor without grease points may be fitted on the machine. This has sealed bearings and requires no lubrication.

EVERY 12 MONTHS : Open the guard at the back of the machine, release the belt (as for changing the speed on page 7) and adjust the motor out until it can be swung away and access obtained to the inside of the machine.
Grease the two screws and the spiral gears.

Wadkin oils and greases with recommended alternatives

Wadkin Grade	Equivalent Lubricants			
	Castrol	Mobil Oil Co.	Shell	Regent/Caltex/Texaco
High Speed Spindle Oil Grade L.1.	Hyspin 70	Mobile DTE Oil Light	Tellus Oil 27	Rando Oil. A
Ball Bearing Grease, Grade L.6.	Spherol AP 3	Mobilux Grease No 3	Alvania Grease No 3	Regal Starfak Premium 3

LUBRICATION POINT B.
BELT TENSION SHAFT

LUBRICATION POINT C.
MOTOR BEARINGS

HANDWHEEL (D)
FOR BELT TENSION
(TENSION UNTIL HANDWHEEL
BEGINS TO LEAVE ITS FACE
SEE NOTES)

LUBRICATION POINT B.
MOTOR SWINGS

MAINS INLET ON SINGLE MACHINE
(ON DOUBLE SPINDLE MACHINES MAINS
INLET IS AT THE FRONT OF THE MACHINE
BENEATH THE ELECTRICAL SWITCHGEAR)

FIG. 4. REAR VIEW WITH GUARD OPEN

CHANGING THE SPEED AND RETENSIONING THE BELT (See Fig. 4)

The cutter spindle speeds available to each individual machine are stamped on the nameplate but the table below gives the relation between the spindle speed and size of motor pulley (assuming a standard 2 pole motor), the larger diameter of the motor pulley giving the higher speed.

To change the speed the driving belt must (with the exception of machines with change pole motors) be moved on to the other step of the motor pulley:—

With the isolating switch "OFF" open the guard at the back of the machine and adjust the motor by turning the handwheel 'D' anticlockwise until the belt is released and can be EASILY fitted to the appropriate diameter of the motor pulley. Re-tension by turning the handwheel clockwise but spin the pulley by hand to ensure that the belt is "tracking" correctly. Continue tensioning ONLY UNTIL THE HANDWHEEL BEGINS TO SCREW ITSELF OUT AND AWAY FROM THE FACE OF THE BRACKET.

NOTE: All belts are marked with two lines spaced $5\frac{1}{8}$ " apart before tensioning, which dimension is increased to $5\frac{5}{8}$ " after correct tension is applied. Should the tensioning procedure described above fail to give the correct tension, the spring pressure should be adjusted as follows:—

With the belt released, wind the motor out until it can be swung away and access obtained to the belt tension shaft inside the machine. This is fitted with a spring of 5" free length, clamped by two locknuts on a left hand thread. Tighten or loosen the spring by means of the locknuts according to whether an increase or decrease in tension is required. The normal setting length of a new spring is $3\frac{1}{2}$ " giving a pressure of 100 lbs., which varies by 8 lbs. for every $\frac{1}{8}$ " of adjustment.

Close the guard before starting the machine.

DIAMETERS OF MOTOR PULLEY	CUTTER SPINDLE SPEEDS IN R.P.M.		LENGTH OF METEOR BELT including 1% stretch when tensioned
	on 50 cycles	on 60 cycles	
$4\frac{3}{4}$ " (120 mm.) & $3\frac{1}{16}$ " (80 mm.)	4,500 & 3,000	5,400 & 3,600	41"
$6\frac{3}{8}$ " (160 mm.) & $3\frac{1}{16}$ " (80 mm.)	6,000 & 3,000	7,200 & 3,600	41"
$6\frac{3}{8}$ " (160 mm.) & $4\frac{1}{4}$ " (120 mm.)	6,000 & 4,500	7,200 & 5,400	41" (Note: Belt is $1\frac{1}{4}$ "
$7\frac{7}{8}$ " (200 mm.) & $5\frac{1}{4}$ " (133 mm.)	7,500 & 5,000	9,000 & 6,000	43 $\frac{1}{2}$ " wide for all lengths).
$9\frac{1}{2}$ " (240 mm.) & $4\frac{3}{4}$ " (120 mm.)	9,000 & 4,500	—	46 $\frac{1}{2}$ "
$9\frac{1}{2}$ " (240 mm.) & $6\frac{3}{8}$ " (160 mm.)	9,000 & 6,000	—	46 $\frac{1}{2}$ "
$3\frac{3}{16}$ " (80 mm.)	3,000	3,600	

TO CHANGE THE BELT (See Fig. 6)

- (1) Release the belt from the motor pulley.
- (2) Remove end plate 'A', together with locking bar 'B' and four $\frac{5}{16}$ " dia. springs 'C'. (Four $\frac{5}{16}$ " hex. headed screws).
- (3) Lower spindle to its lowest position for accessibility.
- (4) Remove the front sheet metal guard 'D'. (Four $\frac{1}{8}$ " button head screws).
- (5) Remove strap 'E' (complete with lever) holding bottom bearing housing. (Two $\frac{1}{2}$ " hex. headed screws).
- (6) Remove strap 'F' (complete with lever) holding top bearing housing whilst supporting the spindle. (Two $\frac{1}{2}$ " hex. headed screws).
- (7) Remove spindle assembly sufficiently to release the belt. Fit new belt (see table on page 6) and reassemble in reversed order keeping all parts clean, especially the bottom bearing housing which is a sliding fit in the bore.

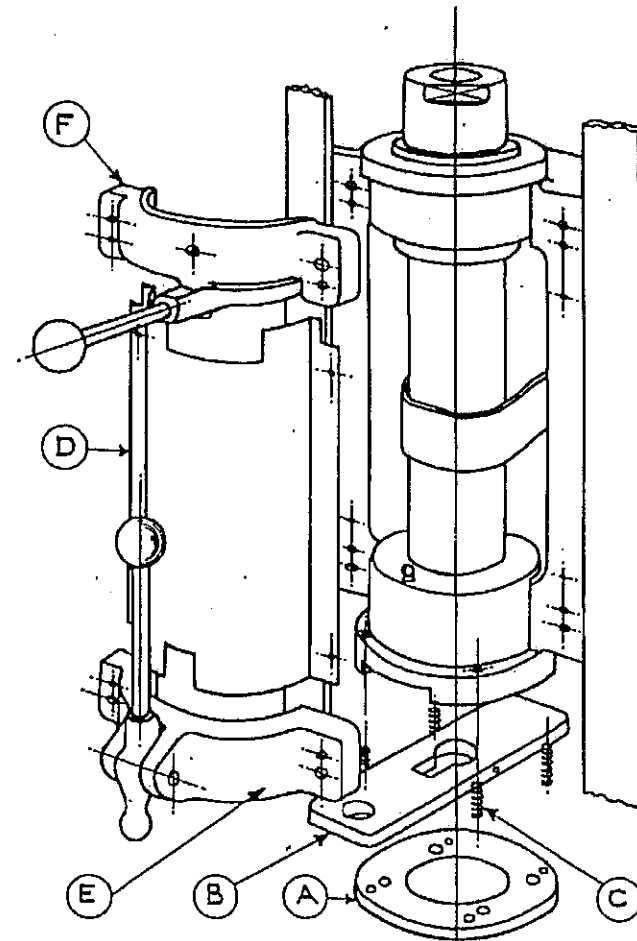

FIG. 6. PART EXPLODED VIEW OF SPINDLE UNIT.

BELT MAINTENANCE

Provided that the belt is not overtensioned or otherwise misused, no maintenance is necessary and no grease or oil should be applied. The pulleys, however, require cleaning periodically on the face to keep the belt face clean, and inside the rim to prevent dust and chips accumulating and causing out of balance running.

THE CUTTER SPINDLE UNIT

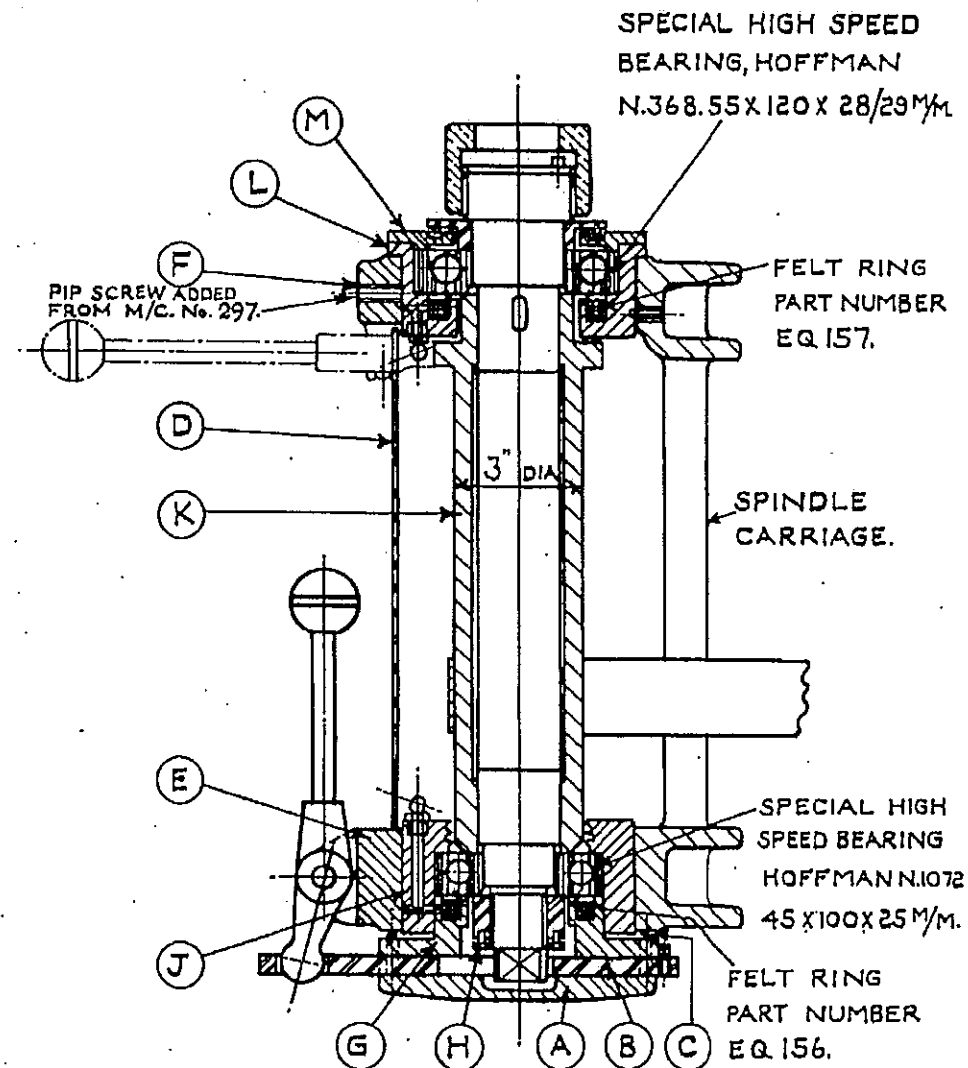

FIG. 7. SECTIONAL VIEW OF SPINDLE UNIT.

DISMANTLING (FOR FITTING NEW BEARINGS) SEE FIG. 7.

- (1) Remove the spindle assembly from the spindle carriage as described under "Changing the belt" on page 8, and place on the workbench. This involves the removal of parts A, B, C, D, E and F.
- (2) Remove bottom end cap 'G' (four $\frac{5}{16}$ " hex. hole cap screws).
- (3) After first releasing the two counter-sunk locking screws, unscrew the bottom locknut 'H'. (This nut is $1\frac{3}{4}$ " across flats and has a left-hand thread, except on the right-hand unit of the double spindle moulder, type EX, when the thread is right-hand).
- (4) Remove bottom bearing housing 'J', complete with ball bearings.
- (5) Remove the driving sleeve 'K'.
- (6) Remove the top bearing housing 'L', complete with ball bearing and cap 'M'.
- (7) Remove the cap 'M', from top bearing housing (four $\frac{5}{16}$ " counter-sunk head screws).
- (8) Tap the bearings out of their respective housings.

Fit new bearings and reassemble in reverse order to the operations above and on page 8.

Clean all parts thoroughly before re-fitting especially inside the ball bearing housings. Renew the felt oil rings if necessary but always soak in Grade L.1 spindle oil before fitting and ensure that the four wicks are in place to feed each bearing.

SERVICE AND SPARES

Given regular attention and maintenance as recommended in this manual, the Wadkin Spindle Moulder should give continuous trouble-free service. Apart from items such as Belts or Bearings, replacement parts are unlikely to be required. For this reason no Spare Parts List is issued. Should, however, any part of the machine sustain accidental damage, necessitating its replacement, the drawings and illustrations in this book will enable the part to be accurately specified and thus enable our Service Department to send the replacement promptly.

Replacement Bearings. The Spindle Ball Bearings as detailed on page 9 are specially made for us by the Hoffmann Manufacturing Co. Ltd. to extra precision limits and we strongly recommend users to order from our Service Department should replacement bearings become necessary.

The Ball Bearings in the motor are commercial bearings and can be obtained from any regular bearing stockist.

Replacement Belts. The "Meteor" belt transmitting power to the spindle is specially made to length and endless to the sizes listed on page 7. All sizes are kept in stock by the Wadkin Service Department.

To ensure efficient running of the machine it is strongly recommended that only Belts supplied by Wadkin are used.

ELECTRICAL INSTALLATION INSTRUCTIONS

The cabling between the motor and the control gear has been carried out by Wadkin Ltd., and it is only necessary to bring the line leads to the machine for it to be put into service. This should be done as follows :

1. Fit triple pole isolating switch near the machine unless it has been supplied to special order by Wadkin Ltd., when it will be fitted and connected to the machine.
2. Connect the line lead to the appropriate terminals. See diagram of connections. The cables should be taken to the machine in conduit and secured to the control gear by locknuts.
3. Connect solidly to earth.
4. Close isolating switch and press start button. If motor does not rotate in the right direction, interchange any two incoming line leads.

FAILURE TO START

1. Electric supply is not available at the machine.
2. Fuses have blown or have not been fitted.
3. Isolating switch has not been closed.
4. Lock-off or stop button has not been released.

STOPPAGE DURING OPERATION AND FAILURE TO RESTART

1. Fuses have blown.
2. Overloads have tripped. They will reset automatically after a short time and the motor can be restarted in the usual manner.

ADJUSTMENTS

For a finer overload setting, set the load indicator to a lower value and vice-versa for a less fine setting.

GENERAL

Check the earth connection from time to time. Users are recommended to display in an appropriate position in the maintenance department a Wadkin Electrical Maintenance Instruction Card, No. 356, which is issued gratis on application.

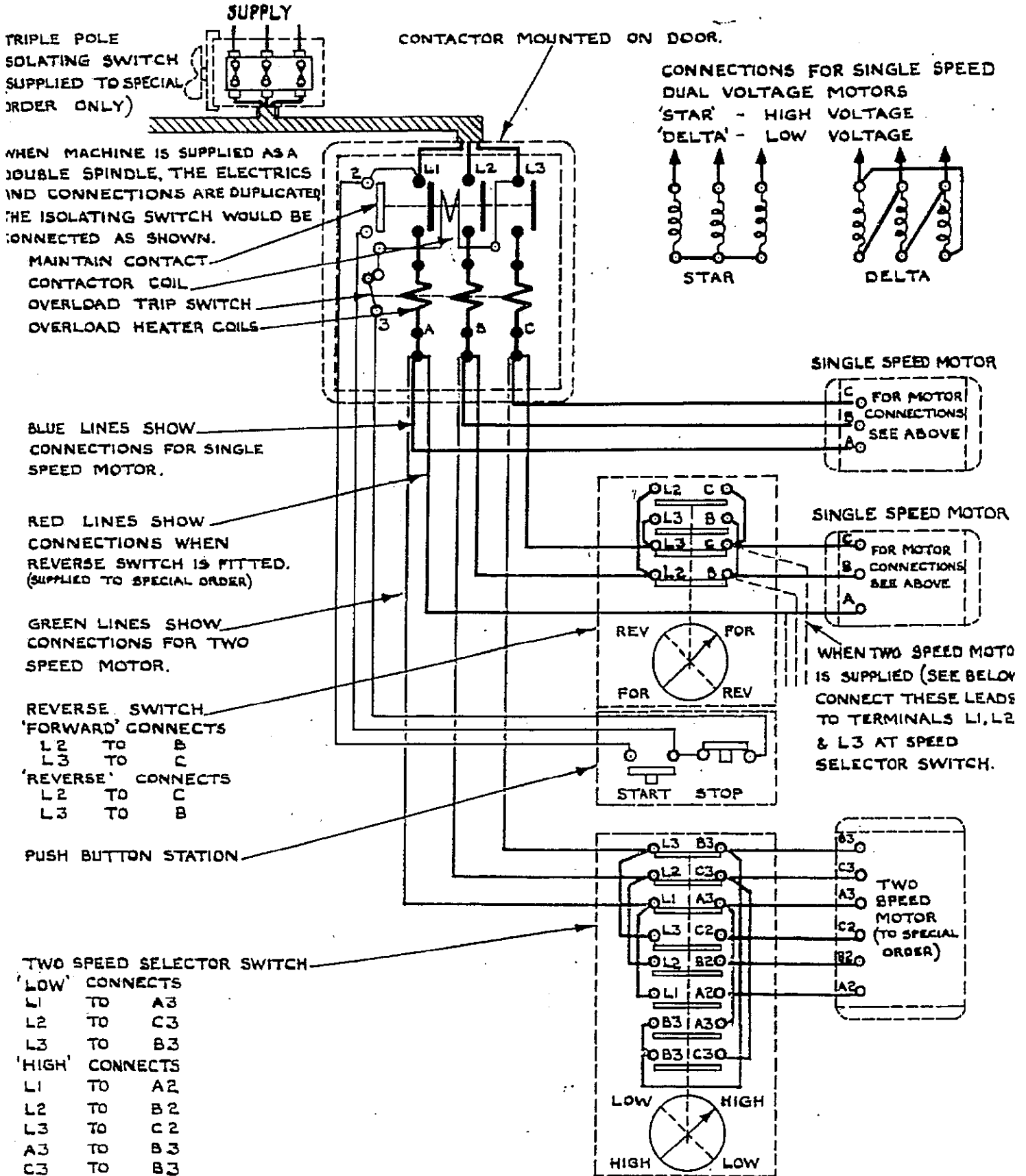

WADKIN LTD.
LEICESTER.

DIAGRAM OF CONNECTIONS

D. 549

CUTTERS AND CUTTER STEELS FOR SPINDLE MOULDERS

Special grades of steel are used for making cutters for different duties and applications on the spindle moulder. The following is a rough guide and when in doubt, our Cutter Department should be consulted.

HIGH SPEED STEEL ON IRON is used for long life and for cutting hard woods. High speed steel is very brittle and the steel on iron is used for all types of unsupported irons. It is used on the square block, slotted collars, thin knife moulding blocks and also for cutters for use on collar type french spindles running at 9,000 r.p.m. A large range of irons for the square block and collars are stocked in this steel.

SOLID HIGH SPEED STEEL is very brittle and is only used where the cutters are supported very close up to the cutting edge, e.g. a thin knife on the circular block, or where a strong section can be used such as a milled to pattern slotted collar cutter.

ALLOY STEEL ON IRON is less expensive than high speed steel on iron, and is more ductile. Our standard range of slotted collar and square block cutters are stocked in this steel. Alloy steel is not so hard and will not stand up to heavy cutting or hard woods as well as high speed steel.

SOLID ALLOY STEEL is normally supplied in bar form in the soft condition for cutting up by the customer. It is easily hardened and tempered and is normally used for french spindle work up to 6,000 r.p.m. where cutters are held by locking screw in spindle, locking direct on to the side of the cutter.

All the above types are supplied in bar form, micrometer ground to precision limits. The alloy and alloy on iron $\frac{3}{16}'' \times \frac{3}{4}''$ up to $\frac{1}{4}'' \times 3''$ in the soft condition and the high speed steel $\frac{5}{32}'' \times 1\frac{1}{2}''$ and $\frac{5}{32}'' \times 2''$, and high speed steel on iron $\frac{1}{4}'' \times 1\frac{1}{4}''$ and $\frac{1}{4}'' \times 1\frac{1}{2}''$ in the heat treated condition. These latter bars cannot be cut with a tool and the blanks should be ordered to grinding lengths so that we can cut them off with a grinding wheel, if the user has not this type of equipment.

For details of all types of cutters, sizes of bar steel and heat treatment see our Small Tools Leaflet, Section C.

All the above cutters can be ground on the usual standard grinding equipment.

TUNGSTEN CARBIDE TIPS. These are specially made for use on hardwoods, woods with high silica content also plywoods and hardboard where High Speed Steel will not stand up to the abrasive action. It is much more expensive but gives very much longer life. We carry a limited range of these cutters for use in slotted collars and square blocks. Special shapes can be supplied to order.

When using Tungsten Carbide Tips, it is necessary to have special grinding equipment; diamond impregnated wheels are required for grinding and diamond hand laps for honing. These are expensive and this should be borne in mind when choosing cutters.

CUTTER EQUIPMENT FOR USE ON SPINDLE MOULDERS

We have given on the following pages maximum sizes and cutting diameters for the equipment shown.

Where it is considered by the customer to be necessary to exceed the figures given, details of the proposed method of working and the moulding to be worked should be sent to Wadkin Ltd., who will be pleased to advise and if necessary recommend special equipment.

Most equipment is offered Right and Left Hand for use on Double Spindles and Single Spindles when a reversing switch is supplied. Equipment listed as Right Hand (R.H.) is suitable for single spindle machines running in the normal direction of rotation as shown in the diagram.

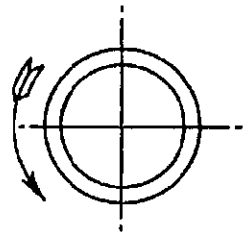

**NORMAL DIRECTION OF SINGLE SPINDLE
LOOKING DOWN ON TOP OF SPINDLE.**

NOTE: It is most important that the recommended speeds of the various types of equipment listed on the following pages are not exceeded. The speeds provided on the **Wadkin Spindle Moulder** are stamped on the nameplate.

STANDARD LOOSE TOP PIECE DETAILS

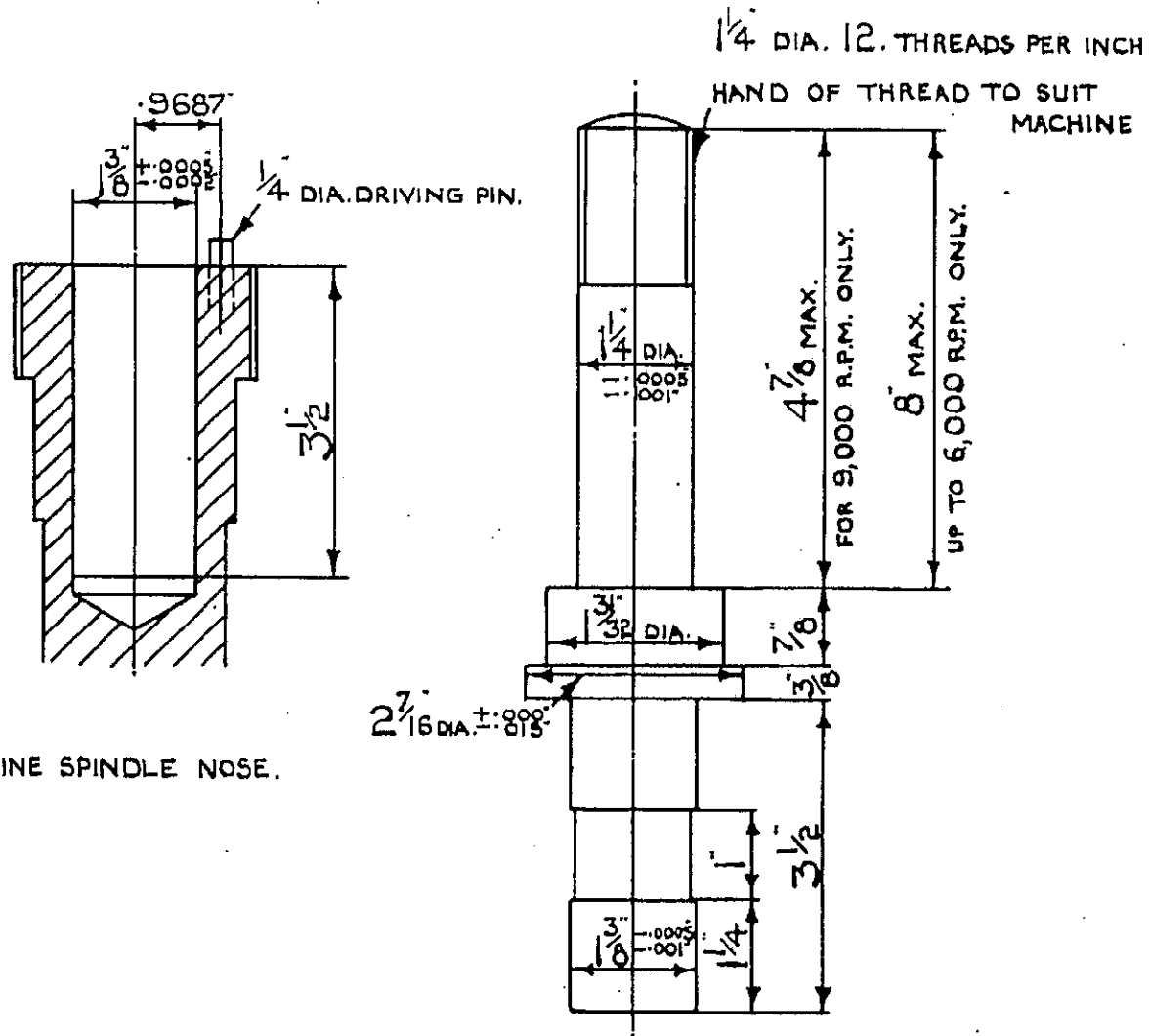

EQUIPMENT FOR USE ON SPINDLE MOULDERS RUNNING AT SPEEDS UP TO 6000 R.P.M.

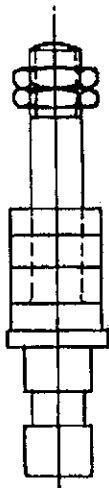

1 1/4" DIA. LOOSE TOP PIECE.

R.H. Spindle Q.X. 22/R.

L.H. Spindle Q.X. 22/L.

These top pieces are used for all equipment on pages 15, 16, 17, 18 and 20.

MAKING UP COLLARS, 1 1/4" BORE.

1/4", 3/4", 1" 1/4", 2" thick, Q.Z. 4,5,6,7,8 and 9.

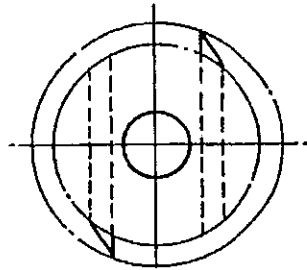

1 1/4" DIA. BORE PLAIN SLOTTED COLLARS 2 1/8" DIA. Q.Y.1.

If required one collar can be supplied a larger diameter to give extra support to cutters.

If vee slotted collars are preferred, these and vee cutters can be offered.

Slotted collar cutters have many advantages, they have good cutting angle, a fairly small cutting circle of 3 5/8" dia., easy to shape, maintain and re-grind and also inexpensive. They are not safe to use above 5" maximum diameter due to the lack of strength and support also the grip on the cutters is less effective as the

cutter is set farther away from the spindle. There can be no side adjustment of collar cutters which is a great disadvantage. We have a limited range of tungsten carbide cutters available and can supply most shapes to order.

3 5/8" minimum 5" maximum diameter cutting circle

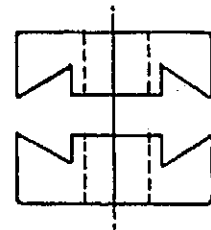
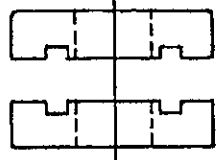

1 1/4" DIA. BORE VEE SLOTTED COLLARS 2 1/8" DIA. E.P. 231.

The vee slots make it possible to use very much thicker cutters, for example the:

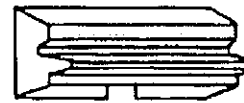

MILLED TO PATTERN COLLAR CUTTERS FOR REVERSIBLE JOINT shown:

(Dimension A 1/2"—1" E.P. 234
A 3/4"—1 1/4" E.P. 235).

These cutters are more expensive but have a very long life and maintain their original form throughout their life. They can be supplied to certain other shapes if customer will give us details of his moulds.

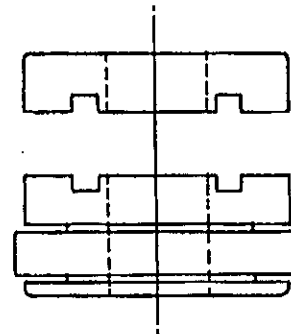
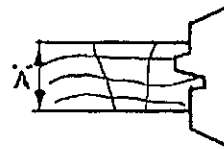

1 1/4" BORE 3 1/8" DIA. BALL BEARING SLOTTED COLLARS. These can be supplied as follows:—

Ball bearing bottom and plain top.

Plain bottom and ball bearing top.

Ball bearing top and bottom.

Ball bearing collar Q.Y. 3.

Plain collar Q.Y. 4.

NOTE:

Where existing 1" dia. bore equipment is already in use, we can offer 1" dia. top piece and all the above collars 1" bore with the same outside diameters.

FOR FULL DETAILS OF ABOVE AND FULL RANGE OF CUTTERS STOCKED SEE SECTIONS C AND D OF OUR TOOLS AND SUNDRIES CATALOGUE.

DETAILS OF SQUARE AND CIRCULAR CUTTERBLOCKS

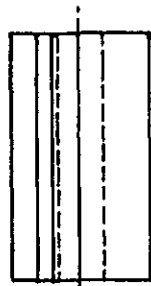
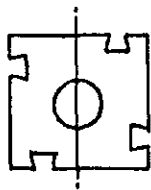

Cutting circle
Minimum $5\frac{7}{8}$ " dia.
Maximum $7\frac{1}{2}$ " dia.

$3\frac{1}{2}$ " SQUARE $1\frac{1}{4}$ " BORE DOVETAIL CUTTERBLOCKS.

LENGTH	PART No.	MAX. SPEED
3"	Q.W. 1	6,000 R.P.M.
4"	Q.W. 2	6,000 R.P.M.
6"	Q.W. 3	4,500 R.P.M.

These cutterblocks are used for longer runs, cutters working in pairs, several pairs may be mounted on a single block to build up mould.

The cutters on these cutterblocks have a very good cutting angle. They are $\frac{3}{8}$ " thick and are securely held by dovetail bolts. It is therefore possible to have a large overhang allowing deep moulds to be worked with safety up to the maximum cutting circle of $7\frac{1}{2}$ " diameter.

For standard cutters see Section C of our Tools and Sundries Catalogue. For High Speed Steel on Iron cutters see F.C.T. 999 range on pages 9 and 10 of the above section.

A limited range of Tungsten Carbide Tipped cutters are available. Shaped cutters can be provided to special order.

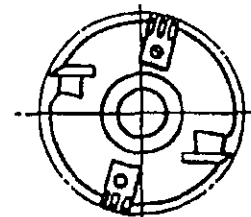
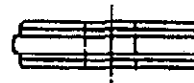
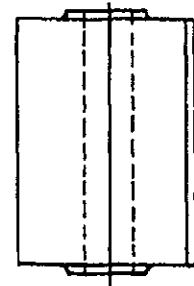
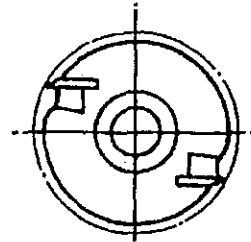

$4\frac{1}{4}$ " DIA. CUTTING CIRCLE $1\frac{1}{4}$ " DIA. BORE SAFETY CIRCULAR CUTTERBLOCK.

LENGTH	PART No.	CUTTERS	MAX. SPEED
2"	Q.H. 2	V.P. 102	9,000 R.P.M.
3"	Q.H. 3	V.P. 103	9,000 R.P.M.
4"	Q.H. 4	V.P. 104	6,000 R.P.M.
6"	Q.H. 6	V.P. 105	4,500 R.P.M.

These cutterblocks have wedge type clamping for safety, also adjusting screws for easy, accurate setting of cutters. They are smooth running and are used for facing. They have a good cutting action and a small cutting diameter of $4\frac{1}{4}$ ".

BALL BEARING GUIDES FOR USE WITH THE ABOVE.

These can be supplied top, bottom or both as required.

$1\frac{1}{4}$ " dia bore Q.A.A. 20.

The Q.H. type circular cutterblocks can, if required, be supplied with spur cutters for shoulder work across the grain.

All the above can be supplied for use with existing 1" dia. top pieces except 6" long blocks Q.W.3 and Q.H. 6.

FOR FULL DETAILS OF THE ABOVE SEE SECTION D OF OUR TOOLS AND SUNDRIES CATALOGUE.

EQUIPMENT FOR USE ON SPINDLE MOULDERS

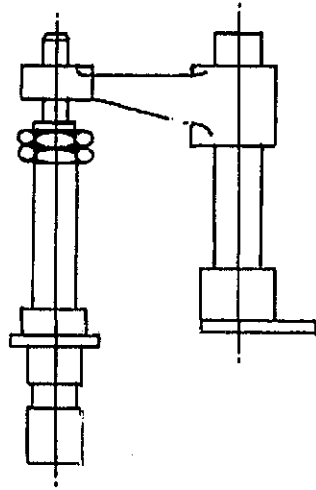

BALL BEARING STEADY AND $1\frac{1}{4}$ " DIA. SPINDLE EVS.33'R.

This is used where deep and very heavy cutting is required, or where work is high above table. It gives support and correct alignment to spindle. It is used for any work more than 6" deep or 6" above the table level.

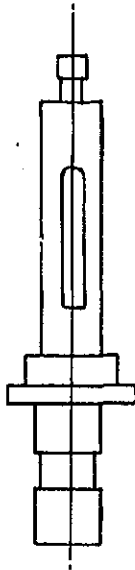

FRENCH SPINDLES, MAXIMUM SPEED 6,000 R.P.M.

DIAMETER	SLOT	PART No.	MAX. CUTTING DIA.
$\frac{1}{2}$ "	$\frac{1}{8}$ "	Q.X. 10	$1\frac{1}{2}$ "
1"	$\frac{1}{4}$ "	Q.X. 11	2"
$1\frac{1}{2}$ "	$\frac{1}{2}$ "	Q.X. 12	$2\frac{1}{2}$ "
$1\frac{3}{4}$ "	$\frac{1}{2}$ "	Q.X. 13	3"
$1\frac{3}{4}$ "	$\frac{1}{2}$ "	Q.X. 14	$3\frac{1}{2}$ "
2"	$\frac{1}{2}$ "	Q.X. 15	4"

These are very cheap to use due to low cost of cutters, are suitable for short runs and small diameters.

They have poor cutting angle, only single edge working and have no support for large cutters.

CUTTERS. See Section 'C' of our Tools and Sundries Catalogue for sizes of bar stocked.

FOR FULL DETAILS OF THE ABOVE SEE SECTION D OF OUR TOOLS AND SUNDRIES CATALOGUE.

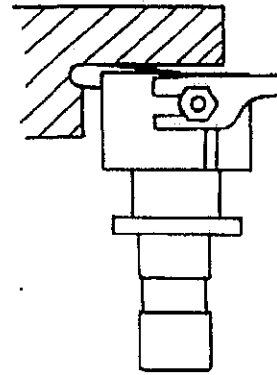

$2\frac{1}{2}$ " SQUARE CUTTERBLOCK E.P.227 FLUSH MOUNTED ON SPECIAL LOOSE TOP PIECE E.P. 225.

This is used for throating work on sills, etc.

Maximum speed 6,000 r.p.m.



Special shaped cutters can be supplied if required. These are $\frac{3}{8}$ " thick.

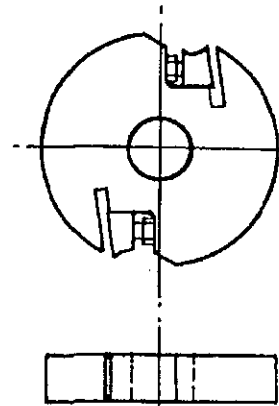

TWO-KNIFE WEDGE TYPE CIRCULAR CUTTERBLOCK, PLAIN BORE Q.R. TYPE.

$4\frac{1}{8}$ " DIA. \times $\frac{1}{16}$ " THICK \times $1\frac{1}{4}$ " BORE, PART No. QR.1. MAXIMUM SPINDLE SPEED, 7,500 R.P.M.

$5\frac{1}{8}$ " DIA. \times $\frac{1}{16}$ " THICK \cdot $1\frac{1}{4}$ " BORE, PART No. QR.4. MAXIMUM SPINDLE SPEED, 7,500 R.P.M.

These cutterblocks are designed to take $\frac{5}{16}$ " up to $\frac{1}{4}$ " thick cutters: this permits tungsten carbide tipped cutters to be supplied when necessary.

The cutters can be used for mouldings requiring not more than $\frac{1}{2}$ " cutter projection when using $\frac{1}{4}$ " thick cutters.

Our standard VZ range of cutters on page 7 of Section D, Tools Catalogue, can be used in these cutterblocks, also existing Whitehill head cutters.

Maximum Cutting Circle
 Cutterhead QR.1 $5\frac{1}{2}$ " diameter
 QR.4 $6\frac{1}{2}$ " diameter
 Using $\frac{1}{4}$ " thick cutters

EQUIPMENT FOR USE ON SPINDLE MOULDERS

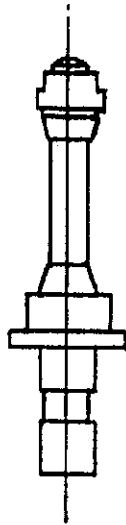

CONED LOOSE TOP PIECE FOR
CONED BORE CUTTERBLOCKS.

R.H. Spindle S.B.F. 121.

L.H. Spindle S.C.F. 575.

This spindle ensures that cutter-
blocks are self-centred and enables
equipment supplied for Wadkin
4" x 4" Planing and Moulding
Machine type F.D. to be used on
Spindle Moulders.

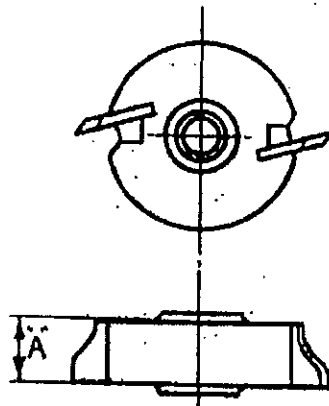

Cutting circle
Minimum 5½" dia.
Maximum 6½" dia.

TWO KNIFE WEDGE TYPE
MOULDING CUTTERBLOCK.

For use on short runs of moulding
where many different shapes are
required. The cutterblanks are
cheap and because they are ¼" thick
they can be ground quickly and
easily.

This is an ideal head for high speed
moulding up to ½" max. depth of
projection:

"A"	PART No.	MAX. SPEED
1½"	F.D.T. 168	9,000 R.P.M.
2½"	F.D.T. 169	9,000 R.P.M.
3"	F.D.T. 170	7,500 R.P.M.

For full range of cutters available see
page 9, Section 'E', Tools and Sun-
dries Catalogue.

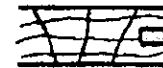
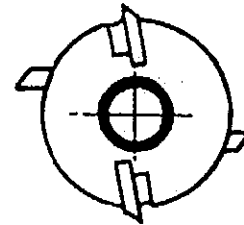

GROOVING CUTTERHEAD

F.D.T. 501.

Complete with adze and grooving
cutters for both L.H. and R.H.
working.

ADZE CUTTERS F.C.T. 1209.

¼" grooving cutters F.D.T. 514.

¾" " " F.D.T. 515.

Will cut ⅜" to ⅞" wide grooves
using only the two sizes of cutters
which are easily adjusted.

Maximum spindle speed 7,500 r.p.m.

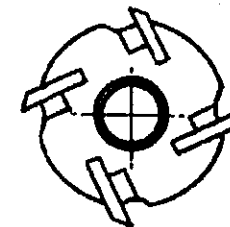

TONGUING CUTTERHEAD

F.D.T. 360.

Complete with four tonguing cut-
ters for both L.H. and R.H. working.
One set of cutters consists of one
pair of each F.D.T. 913 and 914.
These will cut tongues from ⅜" to
⅞" wide, cutters are easily adjusted
for size.

Maximum spindle speed 7,500 r.p.m.

Accurate grinding of tonguing and
grooving heads is important to
ensure good results.

Cutters are serrated backed for
accurate easy setting and to ensure
firm holding.

FOR FULL DETAILS OF THE ABOVE SEE SECTION E OF OUR TOOLS AND SUNDRIES CATALOGUE.

EQUIPMENT FOR USE ON SPINDLE MOULDERS

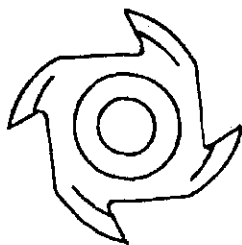

SOLID MOULDING CUTTERS.

Made to any required pattern. When enquiring please send either drawing or sample mould.

These cutters are used where long runs are required and shape must be maintained. Careful and accurate grinding is required to ensure constant results.

Cutters are supplied in High Speed Steel or Carbon Chrome Steel for long life and to stand up to hardwoods.



HIGH SPEED STEEL INSERTED TOOTH GROOVING SAWS.

When enquiring please give width and maximum depth of cut required.

These saws are used for accurate high grade work. They are fairly expensive and require good handling.

They are available in sizes from 6" to 10" diameter, and in varying widths on cut.

Speed for larger diameter saws 3,000 r.p.m.

Speed for smaller diameter saws 4,500 r.p.m.

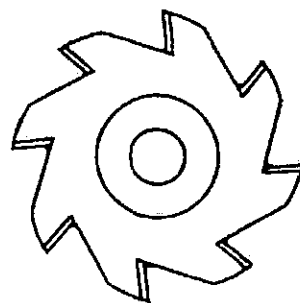
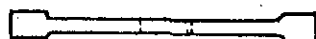
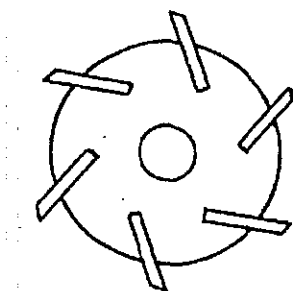

CARBON STEEL SIDE TOOTH CLEARANCE TYPE SAW.

When enquiring please give width and maximum depth of cut required. These are cheaper than inserted tooth saws and are used for general grooving work. They are not suitable for hardwoods.

LIGHT TYPE WOBBLE OR GROOVING SAW UNIT

These saws are used where varied widths of grooving are called for, and where quantities are small. They are not recommended for quantity production or where precision accuracy or the highest standard of finish is required.

8" diam. $\frac{1}{8}$ " to $1\frac{1}{8}$ " grooves.

Maximum 4,500 r.p.m.

10" diam. $\frac{1}{8}$ " to $1\frac{3}{8}$ " grooves.

Maximum 3,000 r.p.m.

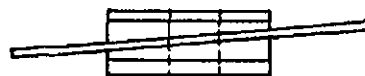

HEAVY TYPE WOBBLE SAW UNIT ON SCREWED SLEEVE

Once set, the saw and collar remain tightly locked on sleeve. This type may be set and kept at its setting when not on machine. It is a self-contained unit.

8" diam. $\frac{1}{8}$ " to $1\frac{7}{16}$ " grooves.

Maximum 4,500 r.p.m.

10" diam. $\frac{1}{8}$ " to $1\frac{3}{4}$ " grooves.

Maximum 3,000 r.p.m.

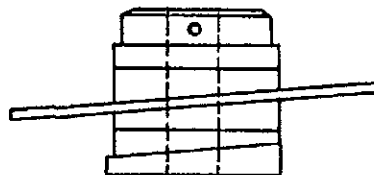

FOR FULL DETAILS OF THE ABOVE SEE SECTIONS A, D,
AND F, OF OUR TOOLS AND SUNDRIES CATALOGUE.

ATTACHMENTS FOR SPINDLE MOULDERS

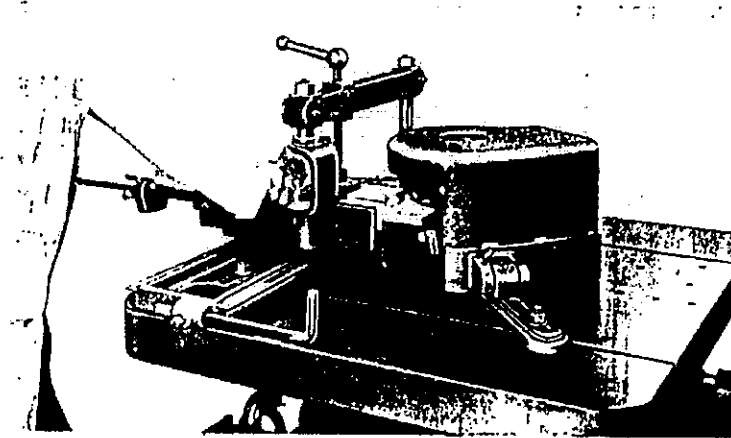

TENONING ATTACHMENT E.G.

When working 5" long tenons, use 3,000 r.p.m. spindle speed only.

For tenons up to 3" x 1½" E.G. 46 & 47 heads 8¾" dia.
 " " " " 5" x 1½" E.G. 40 & 41 " 12½" "
 " " " " 5" x 2" E.G. 38 & 59 " 12½" "

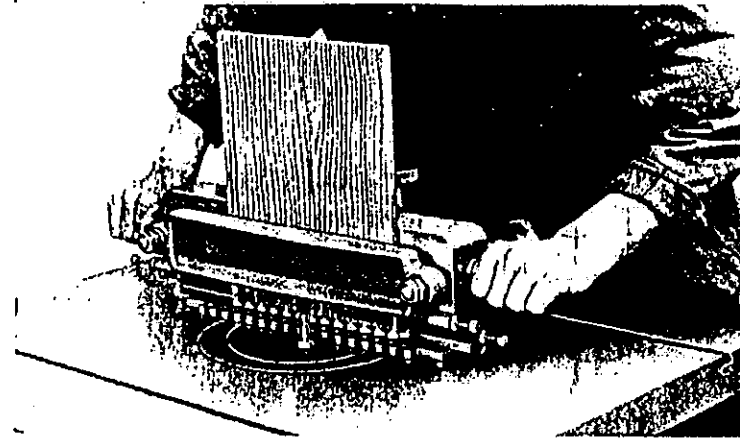

DOVETAILING ATTACHMENT E.E.

This attachment can also be supplied for use at 9,000 r.p.m. using special comb plate, fixed table guide and High Speed Steel cutters.

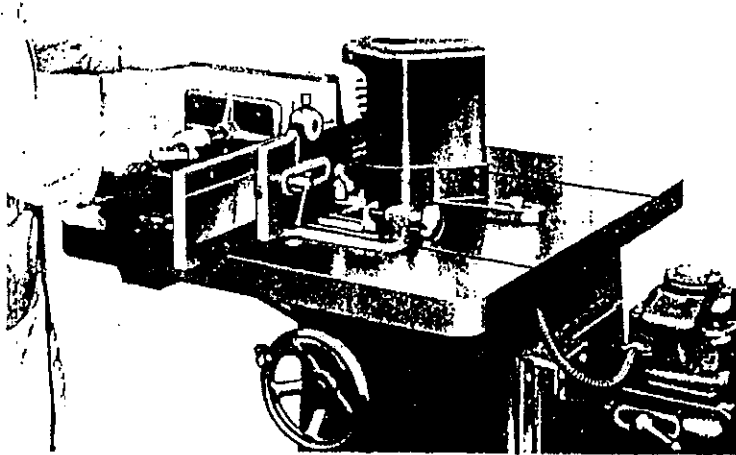

CORNER LOCKING ATTACHMENT E.F. (Speed 4,500 r.p.m.)

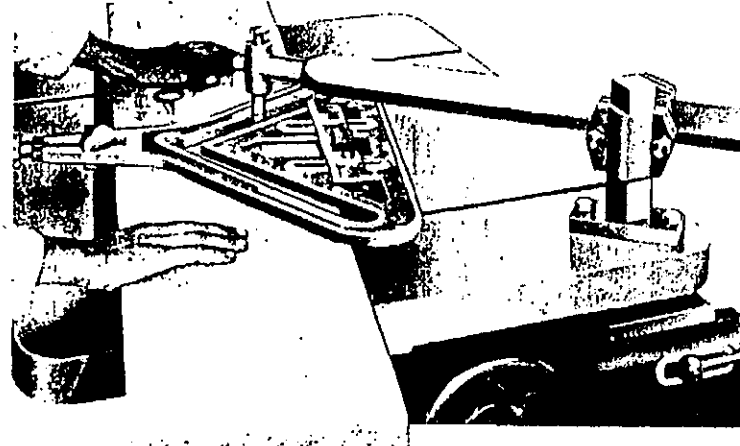

STAIR HOUSING ATTACHMENT. (For speeds up to 9,000 r.p.m.)

FOR FULL DETAILS OF EQUIPMENT FOR EACH OF THESE ATTACHMENTS SEE SECTION D OF OUR TOOLS AND SUNDRIES CATALOGUE.

CUTTER EQUIPMENT FOR USE ON SPINDLE MOULDERS RUNNING AT SPEEDS UP TO 9000 R.P.M.

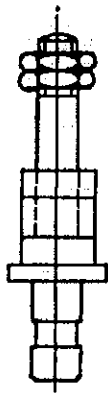

1 1/4" DIA. STUB TOP PIECE.
R.H. Spindle S.B.F. 582.
L.H. Spindle S.C.F. 562.

Making up collars 1/2", 3/4", 1" 1/4" and 1 1/2" thick Q.Z. 4, 5, 6, 7 and 8.

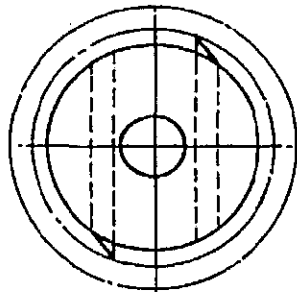

SLOTTED COLLARS. 2 1/8" DIA.
S.B.F. 580 and S.B.F. 581. 1/2" dia. bore
Fitted with safety peg to prevent
cutters coming out when running at
high speed. These have a maximum
width on cut of 2 1/4".

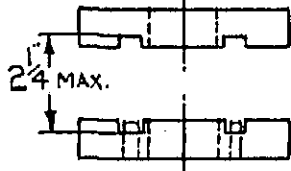

Cutting circle
Minimum 3 1/2" dia.
Maximum 4 3/8" dia.



1/4" wide slots with safety pegs in
bottom collar only.

COLLAR CUTTERS.

With safety slots for use with above.
Made in High Speed Steel on Iron.
3/8" to 2 1/4" on cut x 3" long.

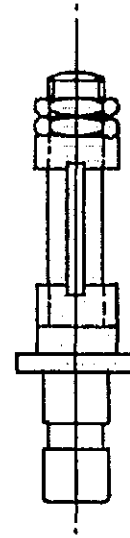

FRENCH SPINDLES COLLAR TYPE.
This type is specially made for safety
at high speeds and gives more sup-
port to cutters.

2" dia. collar French spindle com-
plete with two making up collars.
R.H. spindle E.Q. 300.
L.H. spindle E.X. 20.

Maximum width on cut 2".
Maximum cutting dia. 3 1/2".

2 1/4" dia. collar French spindle com-
plete with three making up collars.
R.H. spindle E.Q. 310.
L.H. spindle E.X. 25.

Maximum width on cut 2 1/2".
Maximum cutting dia. 4 3/8".

Cutters for these spindles are sup-
plied in High Speed Steel on Iron to
stand up to the high spindle speed
and to give longer life.

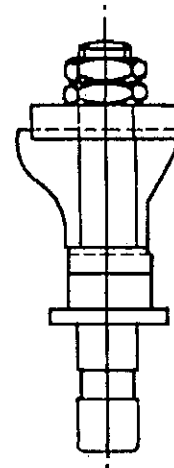

These French Spindles can be fitted
with one large diameter collar to
give extra support to cutters on
deep moulds. Prospective user
should consult Wadkin Ltd. on
these applications.

**NOTE. THE STANDARD RANGE OF EQUIPMENT FOR MACHINES RUNNING
AT SPEEDS UP TO 6000 R.P.M. MUST NOT BE USED ON MACHINES RUNNING AT
HIGHER SPEEDS**

CUTTER EQUIPMENT FOR USE ON SPINDLE MOULDERS RUNNING AT SPEEDS UP TO 9000 R.P.M.

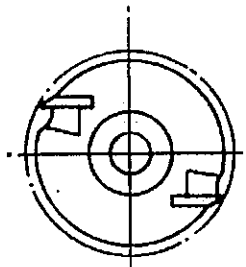

4 1/4" DIA. CUTTING CIRCLE 1 1/4" BORE SAFETY CIRCULAR CUTTERBLOCK.

Maximum depth 3" on stub top piece.
2" on cut Q.H.2. Cutters V.P.102.
3" " " Q.H.3. " V.P.103.
Wedge type clamping.

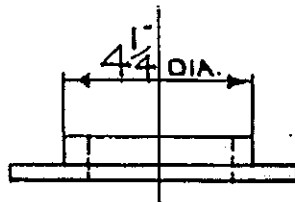
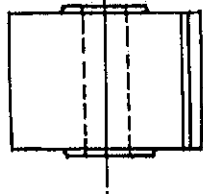

4 1/4" DIA. DEAD GUIDE RING TO FIT IN TABLE, for use with Q.H.2 and 3 cutterblocks.

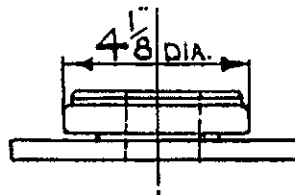

4 1/8" DIA. BALL BEARING GUIDE TO FIT IN TABLE complete with spacing collar for top piece. Due to thickness of guide this may only be used with cutterblock Q.H.2.

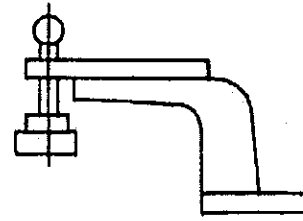

EQZ OVERHEAD GUIDE ROLLER FIXTURE.

This enables maximum capacity to be used on all equipment by guiding above work.

3 5/8" dia. roller EQZ.12 for use with slotted collars.

4 1/4" dia. roller EQZ.14 for use with circular cutterblocks.

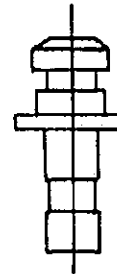

ROUTER COLLET ADAPTER TO TAKE STANDARD "H" TYPE COLLETS.

Supplied complete with 3/8", 1/2" and 7/8" collets.

R.H. Adapter E.P. 223.

L.H. Adapter E.X. 30.

For use with Router cutter equipment.

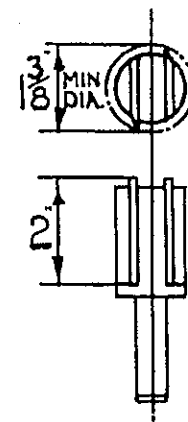

CIRCULAR CUTTERBLOCK L.S.1943.

For both L.H. and R.H. direction of rotation. For light small diameter work.

Cutters L.S. 1943D.

WE RECOMMEND THAT ANY GUIDES REQUIRED AS ABOVE SHOULD BE ORDERED WITH THE MACHINE,
SO THAT THEY MAY BE FITTED BEFORE LEAVING OUR WORKS.

SPINDLE MOULDER GUARDS

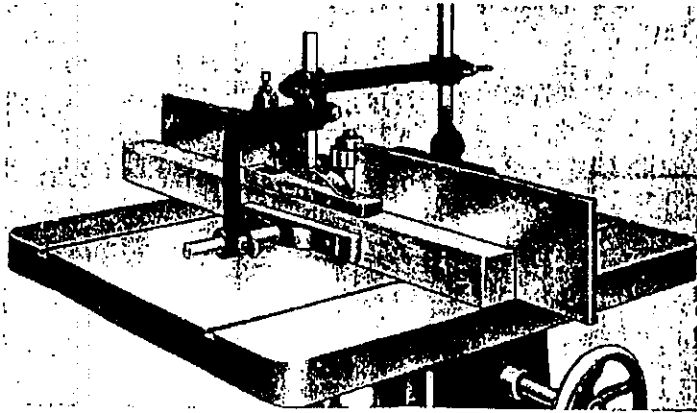

SHAW TYPE GUARD

This guard combines pressure spring, guide and guard. It can be used quite effectively in conjunction with ring fence for curved work. Fully meets the requirements of the Factory Acts. This guard can also be used to good advantage on hand feed surfacing machines.

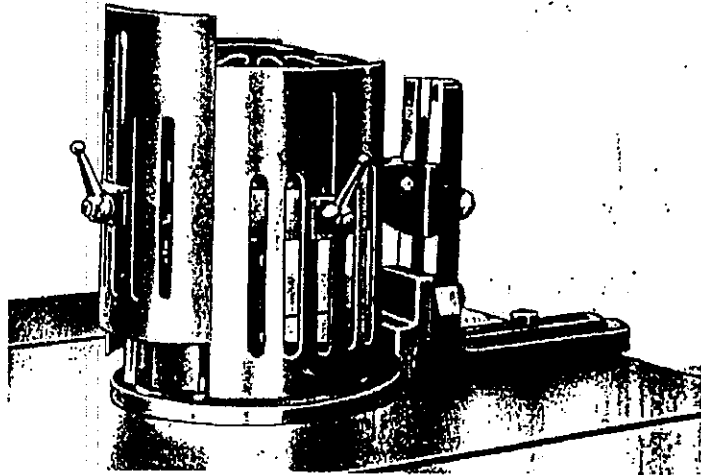

UNIVERSAL ADJUSTABLE TYPE

The use of this very efficient guard is an assurance against accidents on spindle moulders. It can be used for all classes of work and is easily adjustable. The guard swings away when setting the cutters.

It is arranged to carry a ring fence for curved work and when used as a combined guard and ring fence makes a very efficient arrangement.

Two adjustable front shields are provided on the two smaller sizes and three on the large size.

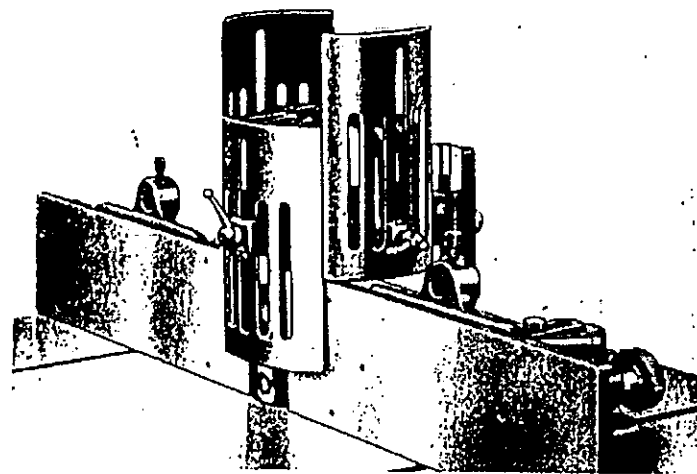

The body of the guard extends upwards to cover the top of the spindle and lock nuts.

The guard fully meets the requirements of the Factory Acts.

Three sizes:—
4", 6" and 8" inside diameter.

The following fence rings can be supplied:—
4½" inside diameter for 6" guard, 6½" inside diameter for 8" guard.

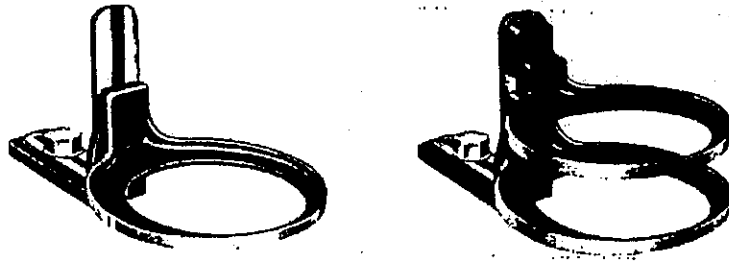

RING FENCES

For use on any spindle moulder, for all kinds of curved work.

Supplied either as single ring or double ring fences, in two sizes:—

6 $\frac{3}{4}$ " internal diameter.

4 $\frac{1}{2}$ " internal diameter.

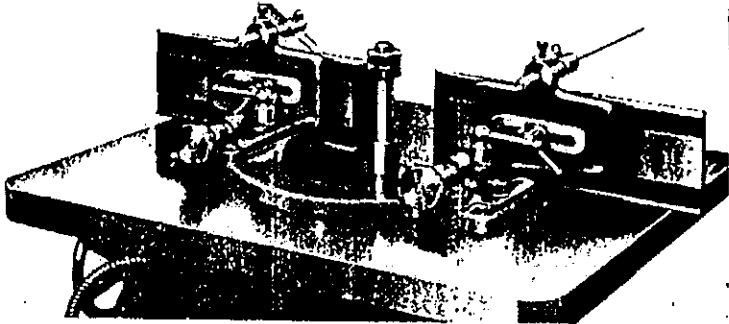

STRAIGHT FENCES

FOR PLAIN TABLE MACHINES.

This fence is of the horseshoe type, requiring no slots in the table. It has independently adjustable front plates each 6" deep. Front plates have lateral sliding movement and have a series of holes for fixing wood fences. Adjustable top and side pressure springs are provided.

This type is used with the Metal cutting spindle moulder Type E.Q.M. for heavy duty work.

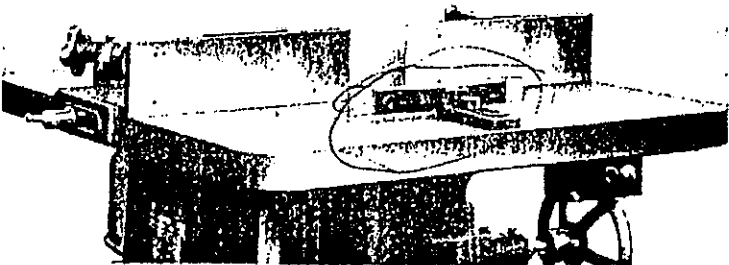

These fences are supplied for use on cabinet and light Moulder work. They are 4" deep, have a fine screw adjustment and are locked in any desired position. Each fence is fitted with a sliding front plate. A side spring pressure is included.

This fence has the advantage that slots or tapped holes in the table top are not required.

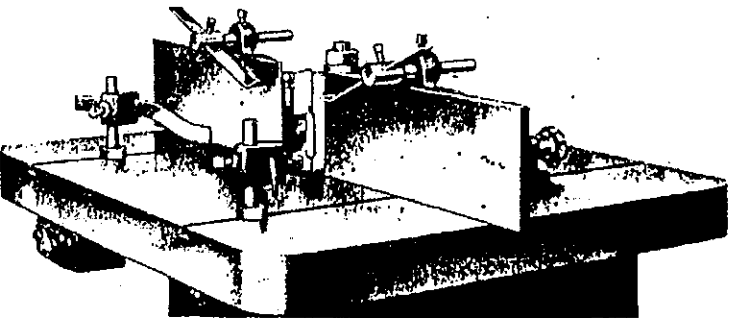

FOR GROOVED TABLES.

These fences are 6" deep, have fine screw adjustment and are locked by lever handles in any desired position. They are quite independent and provided with spigots which fit into the dovetail grooves in the table for ensuring that after an adjustment they remain parallel with each other. Each fence is fitted with precision ground sliding front plate, and each has a number of drilled holes for fixing wood fences when required. Adjustable spring pressures are provided.

SHAPING CUTTERS

When shaping cutters for any mould on any type of cutterhead or slotted collars It is important that the correct allowance is made to the depth of form of cutter.

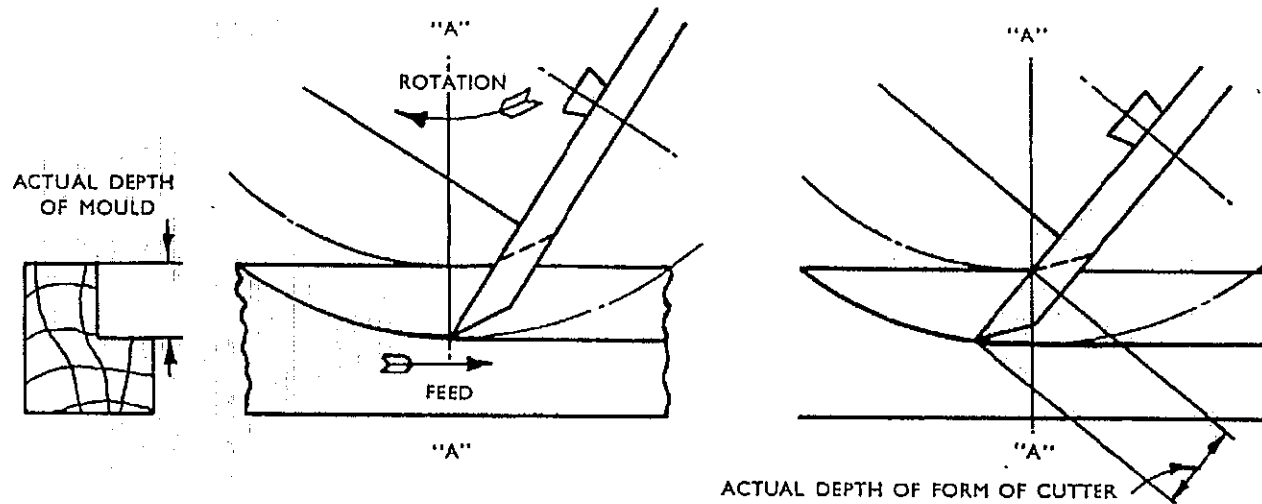

The above illustration shows the projection of the cutter to produce a simple rebate. Using the $3\frac{1}{2}$ " square range of standard cutterblocks, to produce a 1" deep rebate the cutter must have a depth of form of $1\frac{3}{4}$ " this being due to the angle at which the cutter strikes the work on the line A.A. When a shaped mould is required to be cut it is necessary to plot out the form of the cutter, this is shown in the next illustration.

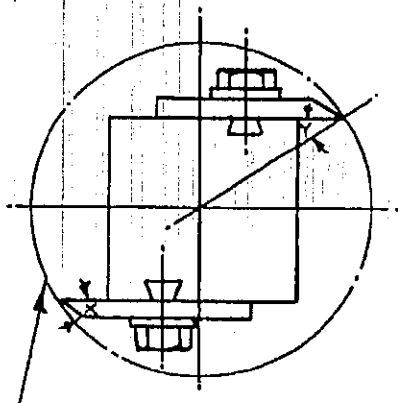

$5\frac{1}{2}$ " DIA. MINIMUM CUTTING CIRCLE

It is important that when selecting blanks from which to make the cutter that they have the minimum necessary overhang to produce the mould. This is essential for safety purposes. Also, a blank as near the shape and width as possible should be selected so that there will be less waste and less chance of overheating cutters when grinding.

The minimum cutting track is fixed to give the necessary clearance for the bolt head when working with chippers only.

The cutter angle which is normally 35° is shown at "X" and the cutting angle at "Y", this angle varies with the size of cutterblock and the depth of the mould.

SHAPING CUTTERS (Contd.)

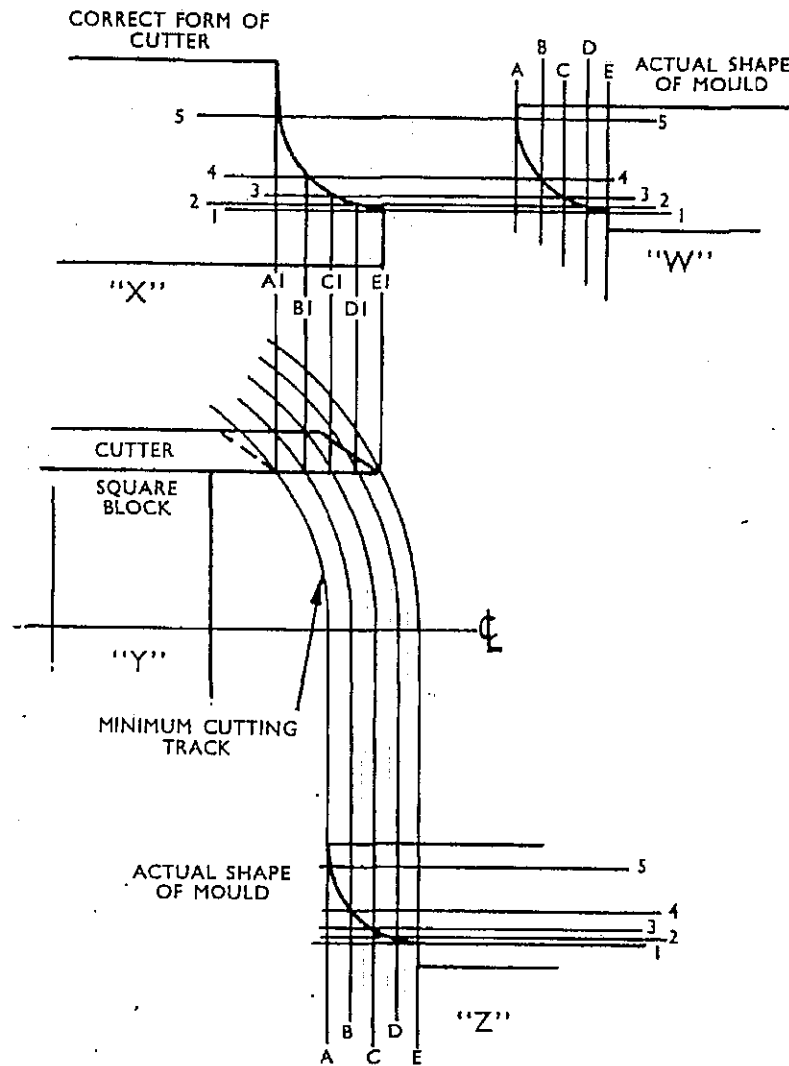

To obtain the correct cutter form for a shaped mould, without using the moulder's rule, it is necessary to plot this out as shown.

First the square block and cutter at minimum track are drawn out full size at "Y", the radius of the minimum track is drawn round to the centre line and projected down, this is then used as the base line for the mould at "Z". The full size mould is then drawn out from this base line and divided up by the lines A, B, C, D and E, into either $\frac{1}{8}$ " or $\frac{1}{16}$ " according to size and intricacy of the shape, these lines are then struck round from the centre line radially to the face of the cutter.

At "X" the lines A1, B1, C1, D1 and E1 are carried across as shown, also at "W" the mould is produced exactly as at "Z" and divided up the same, the lines 1, 2, 3, 4 and 5 which are from the points where lines A, B, C, etc., intersect the edge of the mould, are then drawn across to "X" thus E1 is cut by 1; D1 by 2, etc. The points of intersection are joined as shown thus giving the correct projected form of the cutter.

This takes up considerable time to do for each shape of cutters required, and can be very much reduced by using the moulder's rule on page 28 which is a graph on which the form can be plotted and automatically gives the necessary allowance on the depth of form.

When the mould is to be a standard, a template should be made to the projected form to which the cutters can be shaped when the job repeats. This will ensure uniformity on all future runs.

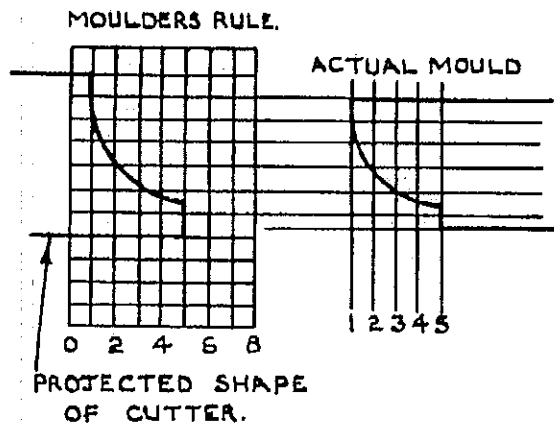

MOULDERS RULE FOR $3\frac{1}{2}$ " SQUARE BLOCKS

$5\frac{7}{8}$ " dia. minimum cutting circle.

$7\frac{1}{2}$ " dia. maximum " "

A permanent moulder's rule can easily be made by the customer in sheet brass or aluminium and will then be handy for use in the workshop.

To plot the form of a cutter by use of the moulder's rule it is necessary to draw the full size shape of the mould on tracing paper and rule $\frac{1}{8}$ " squares as diagram. This is then placed alongside the moulder's rule and projected across, this will give a series of dots which must then be joined up to give the form of the cutter. The cutter blank chosen should be wide enough to give at least $\frac{1}{8}$ " overlap beyond the edge of the mould.

The depth of the form of the cutter for the same mould varies slightly when used on a $3\frac{1}{2}$ " or 4" square cutterblock due to the different cutting diameters. Moulder's rules are required for each size of square block. The cutters are not interchangeable from one size of cutterblock to another if a really accurate mould is required.

SHAPING CUTTERS (contd.)

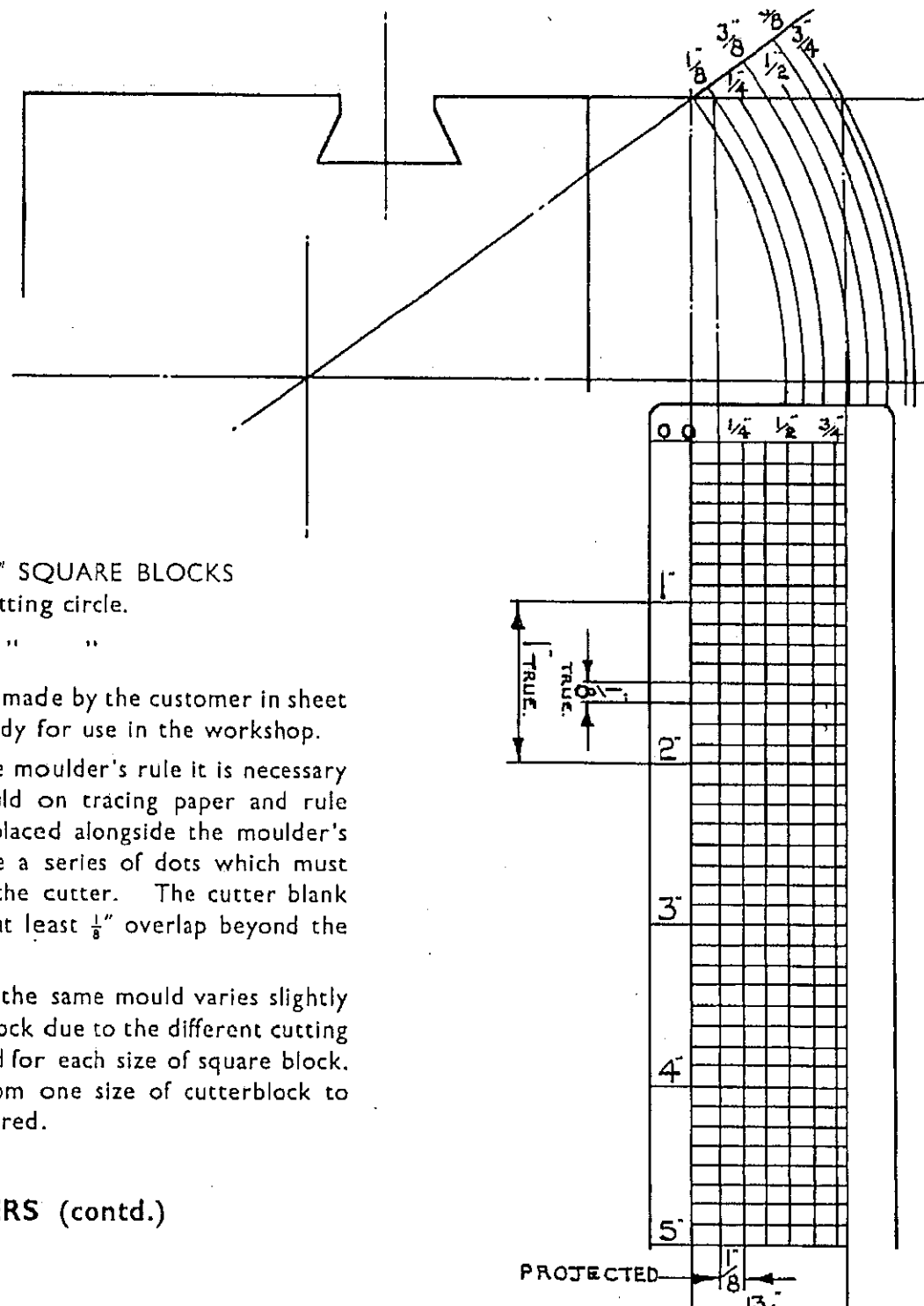

TYPICAL CUTTER LAYOUTS

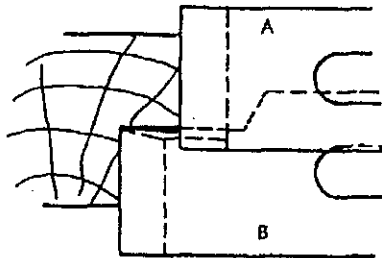

Fig. 1

In all cases where possible when using square blocks it is advisable to break up the cut over two or more pairs of cutters, this has many advantages as is shown in the following examples.

Fig. 1. Simple rebate, by using two pairs of cutters there is very little grinding to be done, only side relief on the cutters B to give a good clean cut and prevent burning, cutters are mounted as shown in Fig. 5. This also spreads cut over the four sides of the block and gives a smoother action.

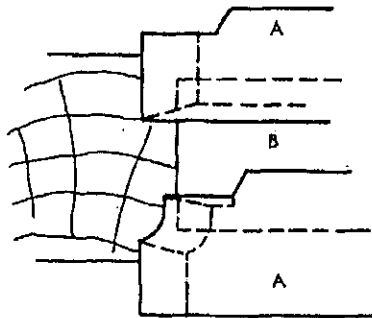

Fig. 2

Fig. 2. Sash mould, this is best worked with three pairs of cutters, this enables correct side relief to be obtained on all cuts, it allows the same cutters to be used with varying widths of mould because they can easily be adjusted sideways.

Figs. 3. and 4. Hand Rail mould, this is broken up into three separate operations. At fig. 3 the top is worked first so that timber runs on flat face, this cut is done by only one pair of cutters. At fig. 4 the sides are worked in two operations, one pair of cutters doing all the side work.

By breaking the moulds up as illustrated, it is possible to use the same cutters for many moulds thus reducing the total quantity of cutters required, it makes grinding of side relief a simple operation and enables exact shape to be obtained by adjusting pairs of cutters across each other. It is essential to have each pair of cutters balanced for smooth running of the cutterblock.

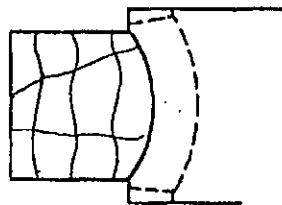

Fig. 3

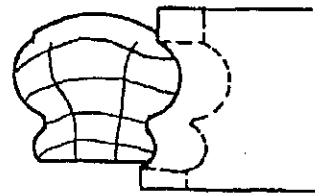

Fig. 4

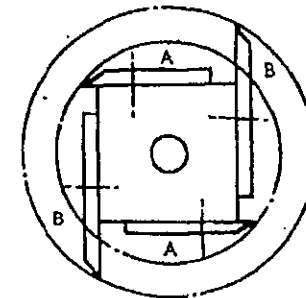

FIG. 5

CUTTER GRINDING

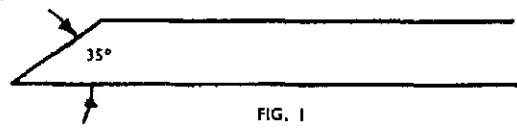

FIG. 1

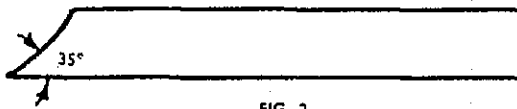

FIG. 2

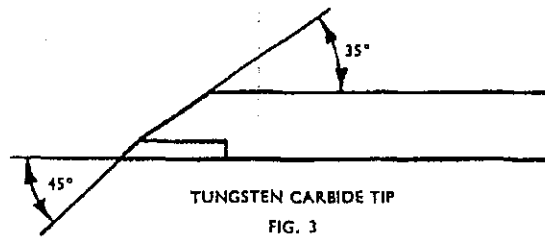

FIG. 3

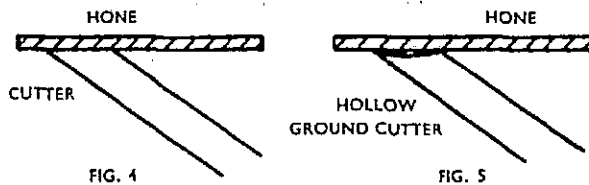

FIG. 4

FIG. 5

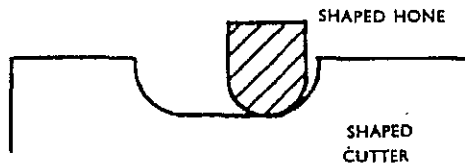

FIG. 6

Cutters should be ground carefully avoiding any overheating as this will crack or soften cutters so that they will not stand up to the work.

A solution of soluble oil and water should be handy and the cutters should be held in this occasionally to cool them. This solution will also prevent rusting. Cutters should never be allowed to become discoloured during grinding, as this indicates overheating.

The correct cutter angle of 35° for most cutters should be maintained, this is to give the correct strength to the cutting edge. When hollow grinding is carried out, the angle of the cutting edge should be kept as near 35° as possible, see Figs. 1 and 2.

Hollow grinding is recommended wherever possible, as a perfect cutting edge is more easily obtained by stoning. When stoning a flat ground cutter a good edge is more difficult to obtain due to the tendency to rock the stone and leave a convex face.

Good open grain wheels should be used and not allowed to become glazed, as this will cause excessive heat.

About 12" diameter for new wheels gives the best radius for the hollow grind and the economic life. 8" wheels used down to 6" leave the grind too hollow.

Tungsten carbide tipped cutters should be bought to the shape required and only need re-grinding. In this case cutters should be relieved at 35° on steel and the tips finished with a diamond impregnated wheel at 45° as shown, using only very light cuts to prevent cracking. The diamond wheel should not be allowed to touch the steel backing as this clogs the wheel and causes excessive heat. Where available a copious flow of coolant should be used. They may be honed with a Diamond hand lap, as the cutter becomes dull, until a re-grind is necessary. A thin oil lubricant should be used on the hand lap.

HONING.

All cutter blanks sent out by us are ground only and if used as chippers or rebate cutters require honing with a 142 Carborundum slip stone to produce a razor sharp edge before commencing to cut. This will ensure a good finish on the wood and an easy feed. Dull cutters give a poor, rough and plucked out finish, and make it difficult to feed the job past the cutters. Honing should be done by a reciprocating or rotary motion on the cutter, using a little paraffin to give "bite" to the stone. The honing stone is a much finer grit than the grinding wheel and leaves a sharp keen edge. A number of honing stones of different shapes, e.g. round sticks or square sticks will be found helpful in honing shaped cutters.

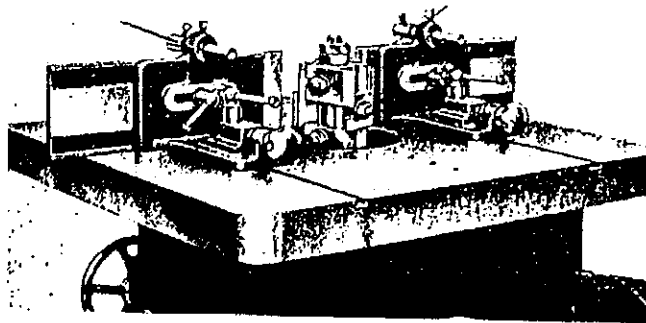
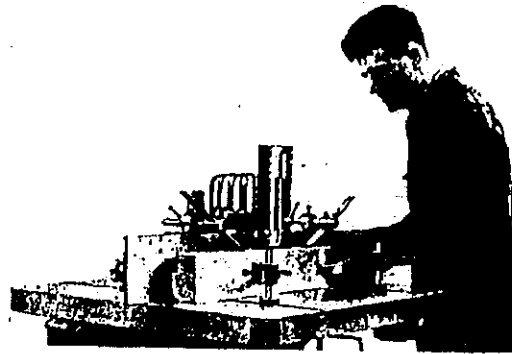

TYPICAL SET UPS

FRAMING ON SQUARE BLOCK

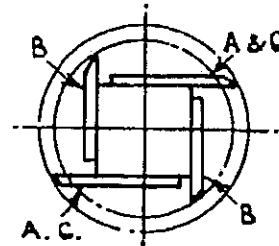
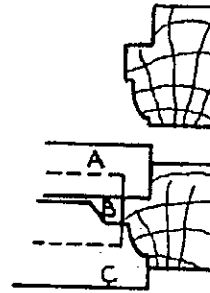

Equipment required:— $1\frac{1}{4}$ " loose screwed spindle, square block, three pairs of cutters, straight fences and spring pressures.

The cutters will have to be shaped to suit the moulded portion, allowing for angle by using the "moulder's rule". Each pair of cutters must be balanced to prevent vibration, then accurately set up on the square block using our setting and balancing stand F.D.T. if available, so that all are cutting. The cutterblock is then mounted on the spindle, fences set correctly in line, top and side spring pressure set to hold work firmly to the fences. Also universal adjustable guard over the top.

Spindle speed 4,500 r.p.m.

Note: Cutters are always used in pairs to maintain balance.

SHAPED PANELS ON SLOTTED COLLARS

Equipment required:— $1\frac{1}{4}$ " loose screwed spindle, one pair slotted collars ball bearing top, one pair shallow nosing cutters and a universal adjustable guard.

The cutters are set up in the collars keeping minimum track in line with ball bearing guide on top collar, collars are mounted on $1\frac{1}{4}$ " dia. loose top piece, the brush handle is held by spikes to master former which is on top of the work.

The universal guard is set to cover cutters and top piece. The former is passed across guide. The cutters are completely shielded from operator's hands by the work.

Spindle speed 6,000 r.p.m.

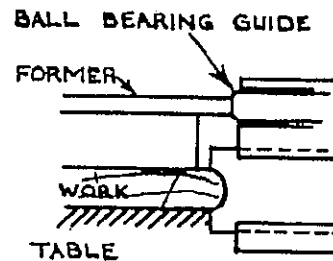
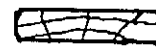

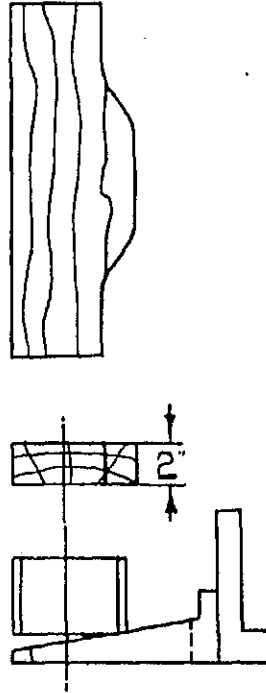
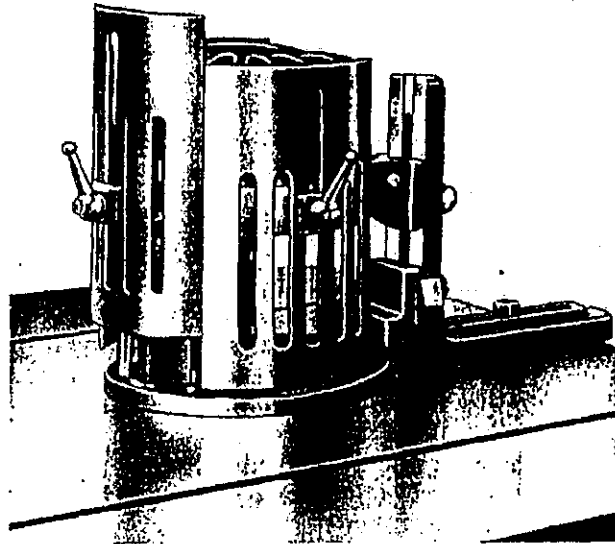

CIRCULAR CUTTERBLOCK WORK

Equipment required:— $1\frac{1}{4}$ " loose top piece
3" deep circular cutterblock, ring fence and
universal adjustable guard.

Cutterblock is mounted on $1\frac{1}{2}$ " top piece
and set so that cuttertrack is in line with
ring fence as shown in sketch. Guard is
then set to cover up block and top piece
leaving only sufficient room for work to
pass underneath. Work to be mounted on
shaped fixture which is held up to ring
fence. Contact must always be at the
same point on ring fence to ensure even
depth of cut. This must be done due to
the shape of the ring.

The circular block gives a good smooth cut
and finish to work.

GENERAL HINTS

Use sharp cutters, reasonably balanced.

Make good robust jigs and see the parts are located securely on the jig. Wadkin are always pleased to make recommendations and send a sketch of the construction of a jig.

NEVER run the cutter equipment at higher than the recommended speed.

Always use the guards provided to ensure maximum protection.

Make sure the cutters are tight on the block before starting up. Use the spanners provided and do not fit a piece of piping to get greater leverage. This will strain the nuts and bolts and ultimately make them unsafe.

NEVER pack cutters with sandpaper. This is most dangerous as the grit collapses when the cutter is working and the cutter works loose. For packing use one thickness only of thin brown paper.

Keep nuts and bolts clean and use oil on the threads.

SPARE PARTS BOOKLET

FOR

EQ

VERTICAL SPINDLE

MOULDER AND SHAPER

SAMPLE TYPE ORDER

MACHINE: EQ

MACHINE NO. 1407

TEST NO: 68975

PARTS REQUIRED

1 - EQ1011/EQ13R GUARD OVER MOTOR PULLEY

1 - EQ1011/EQ65 LOCKING STUD

1 - EQ1011/EQ210 HEAVY DUTY TABLE

1 - EQ1011/EQ259 BELT TENSION SCREW

1 - EQ1011/EV16 FENCE PLATE

EQ SPARE PARTS LIST

EQ1011/EQ2	TABLE (With Dovetail Slots for E.P. Type Fence)
EQ1011/EQ3	TABLE (Without Dovetail Slots for E.Z. Type Fence)
EQ1011/EQ4	ELEVATING SCREW BRACKET
EQ1011/EQ9	SPIRAL GEAR ON RAISING SCREW
EQ1011/EQ13R	GUARD OVER MOTOR PULLEY
EQ1011/EQ15	RIGHT HAND FENCE BASE (EZ TYPE FENCE)
EQ1011/EQ16	LEFT HAND FENCE BASE (EZ TYPE FENCE)
EQ1011/EQ40	MOTOR PULLEY ($6\frac{1}{8}$ "/ $4\frac{1}{4}$ ")
EQ1011/EQ48	MOTOR SWING BRACKET (TOP)
EQ1011/EQ49	MOTOR SWING BRACKET (BOTTOM)
EQ1011/EQ50/R	GUARD OVER MOTOR PULLEY
EQ1011/EQ57	SPIRAL GEAR ON HANDWHEEL SHAFT
EQ1011/EQ58/A	ELEVATING HANDWHEEL SHAFT
EQ1011/EQ60	ELEVATING SCREW L.H.
EQ1011/EQ64	SPACING SLEEVE FOR LOCKING STUD
EQ1011/EQ65	LOCKING STUD
EQ1011/EQ131	ELEVATING NUT (R.H. UNIT)
EQ1011/EQ201	TABLE (EV TYPE FENCES)
EQ1011/EQ203	HANDWHEEL BRACKET
EQ1011/EQ205	BELT TENSION BRACKET
EQ1011/EQ218	MAIN FRAME
EQ1011/EQ250	LEFT HAND SLIDE STRIP
EQ1011/EQ251	RIGHT HAND SLIDE STRIP
EQ1011/EQ252	WEAR STRIP
EQ1011/EQ253	LOCKING PLATE
EQ1011/EQ254	MOTOR PIVOT SHAFT

EQ1011/EQ255	BLOCK FOR BELT TENSION SCREW
EQ1011/EQ256	TOP PIVOT PIN BELT TENSION SCREW
EQ1011/EQ257	BOTTOM PIVOT PIN BELT TENSION SCREW
EQ1011/EQ259	BELT TENSION SCREW
EQ1011/EQ261	STUD FOR BELT GUARD
EQ1011/EQ263	BELT TENSION SPRING
EQ1011/EQ264	COVER FOR MAIN FRAME
EQ1011/EQ269	DRIVING BELT (SPEEDS UP TO 3000, 4500, 6000, 5000, & 7500 rpm.)
EQ1011/EQ375	NUT FOR BELT TENSION SCREW
EQ1011/EV7/A	CENTRE PLATE
EQ1011/EV11	RING FOR CENTRE PLATE
EQ1011/EV16	FENCE PLATE
EQ1011/EV28	FENCE LOCKING PLATE
EQ1011/EV29	FENCE BASE
EQ1011/EV51	SPRING FOR FENCE R.H.
EQ1011/EV52	SPRING FOR FENCE L.H.
EQ1011/EV65	SPRING FOR FENCES
EQ1011/EV66	POST FOR SPRING HOLDER
EQ1011/EV74	OUTER CENTRE PLATE
EQ1011/EV75	SPINDLE FOR FENCE
EQ1011/EZ49	FENCE SLIDE R.H.
EQ1011/EZ50	FENCE SLIDE L.H.
EQ1011/EZ58	BEARING FOR FENCE ADJUSTING SCREW
EQ1011/EZ132	FENCE PLATE
EQ1011/EZ171	FENCE ADJUSTING SCREW

EQ1011/JP474	SPRING HOLDER FOR FENCE
EQ1011/JP450	SPRING HOLDER FOR TABLE
EQ1011/SKFO.8	BEARING
EQ1011/SN011	COMPO BUSHES
EQ1011/1	COLLAR
EQ1011/1	GREASE RETAINER
EQ1011/1A	DOOR HINGES
EQ1011/1B	DOOR HANDLE
EQ1011/1B	HANDWHEEL
EQ1011/2	COLLAR
EQ1011/2	HORN HANDLE
EQ1011/2A	STAR HANDWHEEL
EQ1011/2B	STAR HANDWHEEL
EQ1011/3	LOOSE COLLARS
EQ1011/3B	HANDWHEEL
EQ1011/3B	TWO BALL HANDLE
EQ1011/7B	LOOSE COLLARS
EQ1012/N368	TOP SPINDLE BEARING
EQ1012/N1072	BOTTOM SPINDLE BEARING
EQ1012/EQ60	ELEVATING SCREW L.H.
EQ1012/EQ115	NUT FOR SPINDLE TOP R.H. THREAD
EQ1012/EQ120	SPINDLE YOKE
EQ1012/EQ121	TOP BEARING STRAP
EQ1012/EQ122	BOTTOM BEARING STRAP
EQ1012/EQ123/A	SPINDLE PULLEY
EQ1012/EQ124	TOP BEARING HOUSING
EQ1012/EQ125/A	BOTTOM BEARING HOUSING
EQ1012/EQ126	TOP END CAP
EQ1012/EQ127	BOTTOM BEARING END CAP

EQ1012/EQ128	LOCKING BAR CAP (AND SPRING RETAINER)
EQ1012/EQ129	SPINDLE LOCK LEVER
EQ1012/EQ131	ELEVATING NUT (R.H. UNIT)
EQ1012/EQ156	FELT PAD FOR BOTTOM BEARING
EQ1012/EQ157	FELT PAD FOR TOP BEARING
EQ1012/EQ159	SPINDLE LOCK HANDLE
EQ1012/EQ170	SPINDLE (R.H. UNIT)
EQ1012/EQ172/A	LOCKING PLATE
EQ1012/EQ173	TOP DUST COVER
EQ1012/EQ174	BOTTOM LOCKNUT (R.H. UNIT)
EQ1012/EQ176	FRONT COVER FOR SPINDLE
EQ1012/EQ180	SHOULDER SCREW FOR BRAKE PIVOT
EQ1012/EQ181	PLUNGER FOR SPINDLE LOCK
EQ1012/EQ182	BEARING RETAINER SPRING
EQ1012/EQ183	SPINDLE BRAKE HANDLE
EQ1012/EQ274	BRAKE LEVER
EQ1012/EQ363	DUST SEAL FOR BEARING HOUSING
EQ1012/EV81	DRIVING PIN FOR CHUCK
EQ1012/ME136	SPRING
EQ1012/PC4	WAKEFIELD OIL NIPPLE
EQ1012/QAJ212	INSTRUCTION PLATE
EQ1012/YK72	LEVER PIN
EQ1012/YK91	BRAKE LINING
EQ1012/1	BAKELITE KNOB

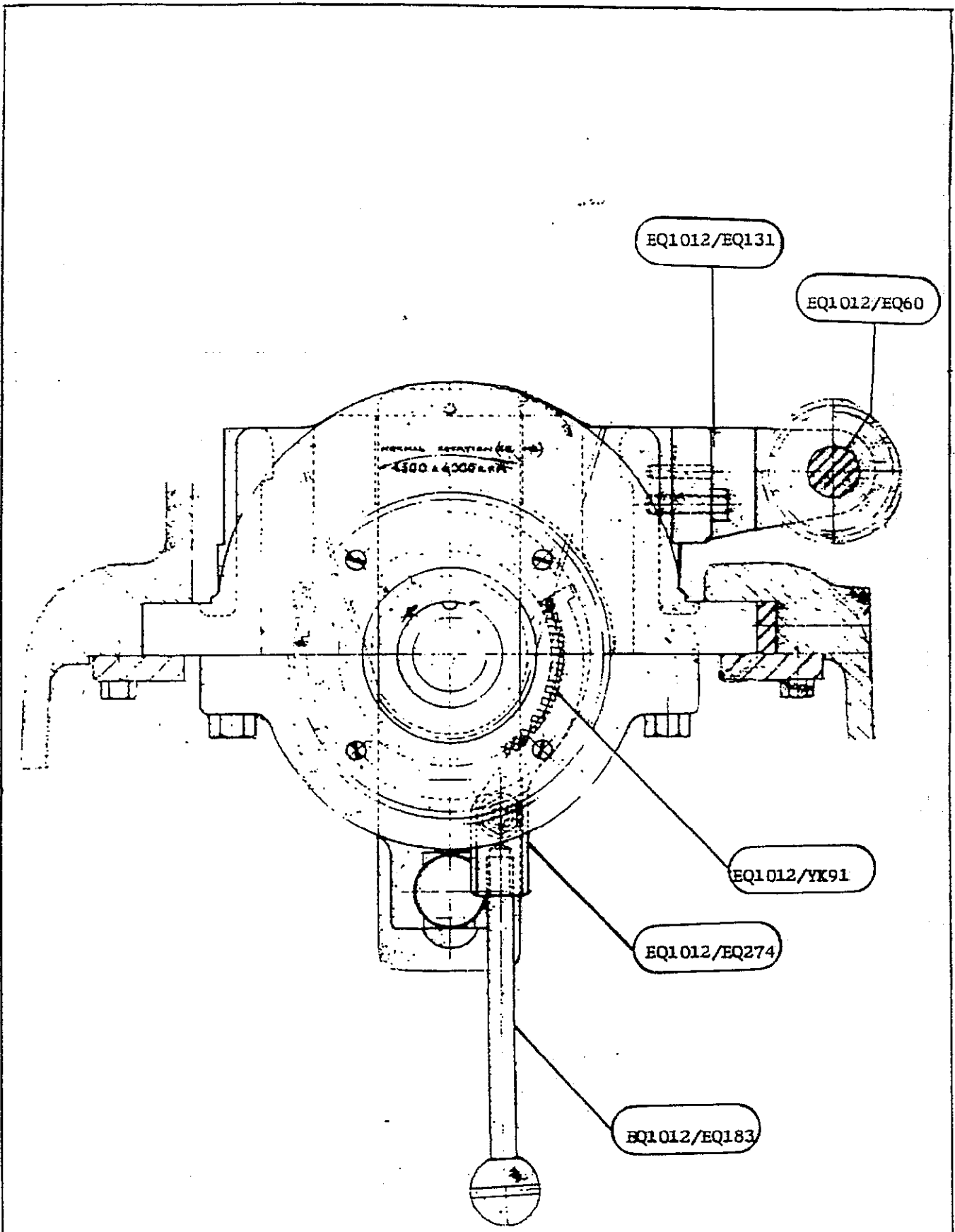

TOP VIEW OF SPINDLE HEAD

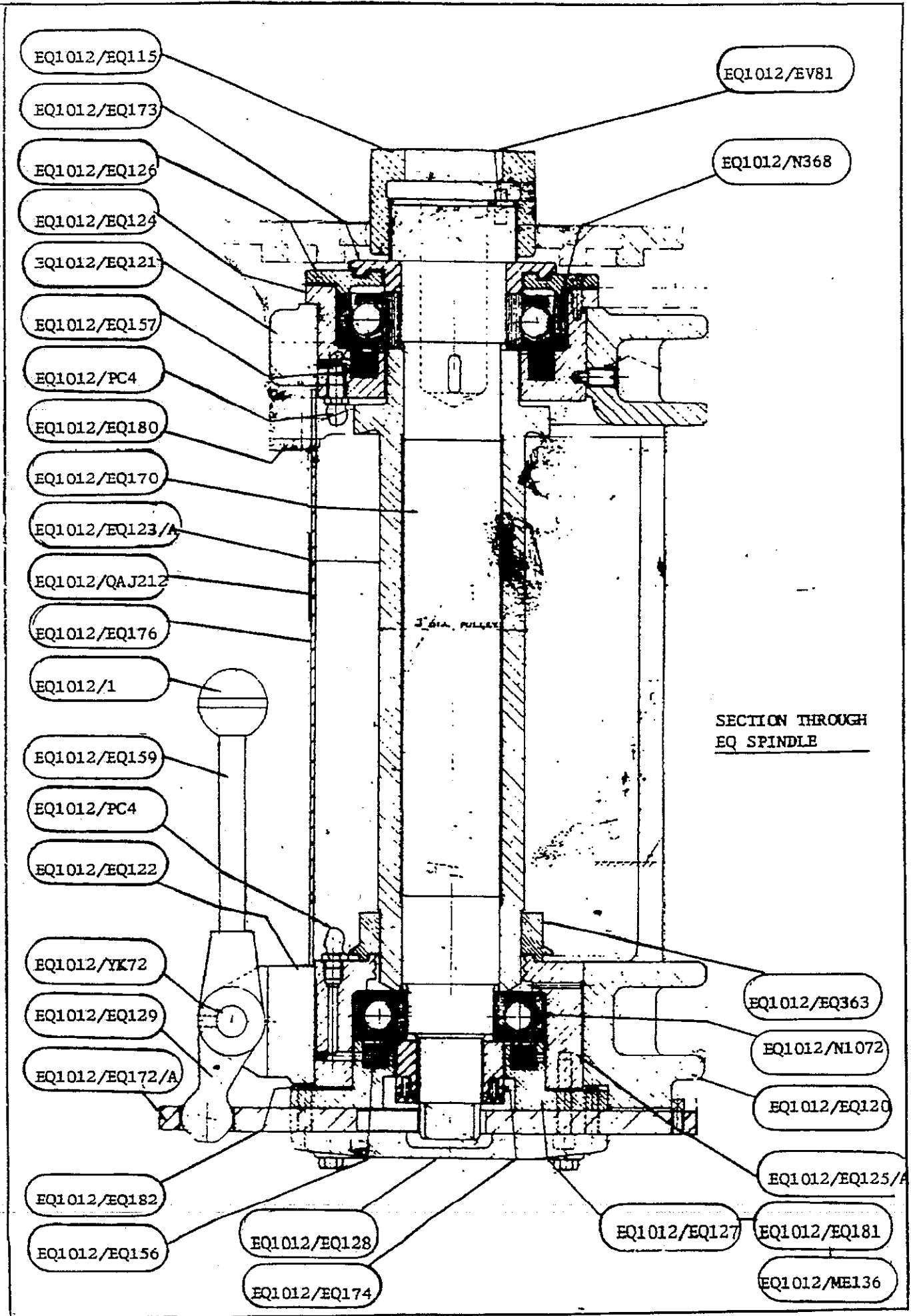

EQ1012/EQ115

EQ1012/EV81

EQ1012/EQ173

EQ1012/N368

EQ1012/EQ126

EQ1012/EQ124

EQ1012/EQ121

EQ1012/EQ157

EQ1012/PC4

EQ1012/EQ180

EQ1012/EQ170

EQ1012/EQ123/A

EQ1012/QAJ212

EQ1012/EQ176

EQ1012/1

SECTION THROUGH
EQ SPINDLE

EQ1012/EQ159

EQ1012/PC4

EQ1012/EQ122

EQ1012/YK72

EQ1012/EQ363

EQ1012/EQ129

EQ1012/N1072

EQ1012/EQ172/A

EQ1012/EQ120

EQ1012/EQ182

EQ1012/EQ125/A

EQ1012/EQ156

EQ1012/EQ128

EQ1012/EQ127

EQ1012/EQ181

EQ1012/EQ174

EQ1012/ME136

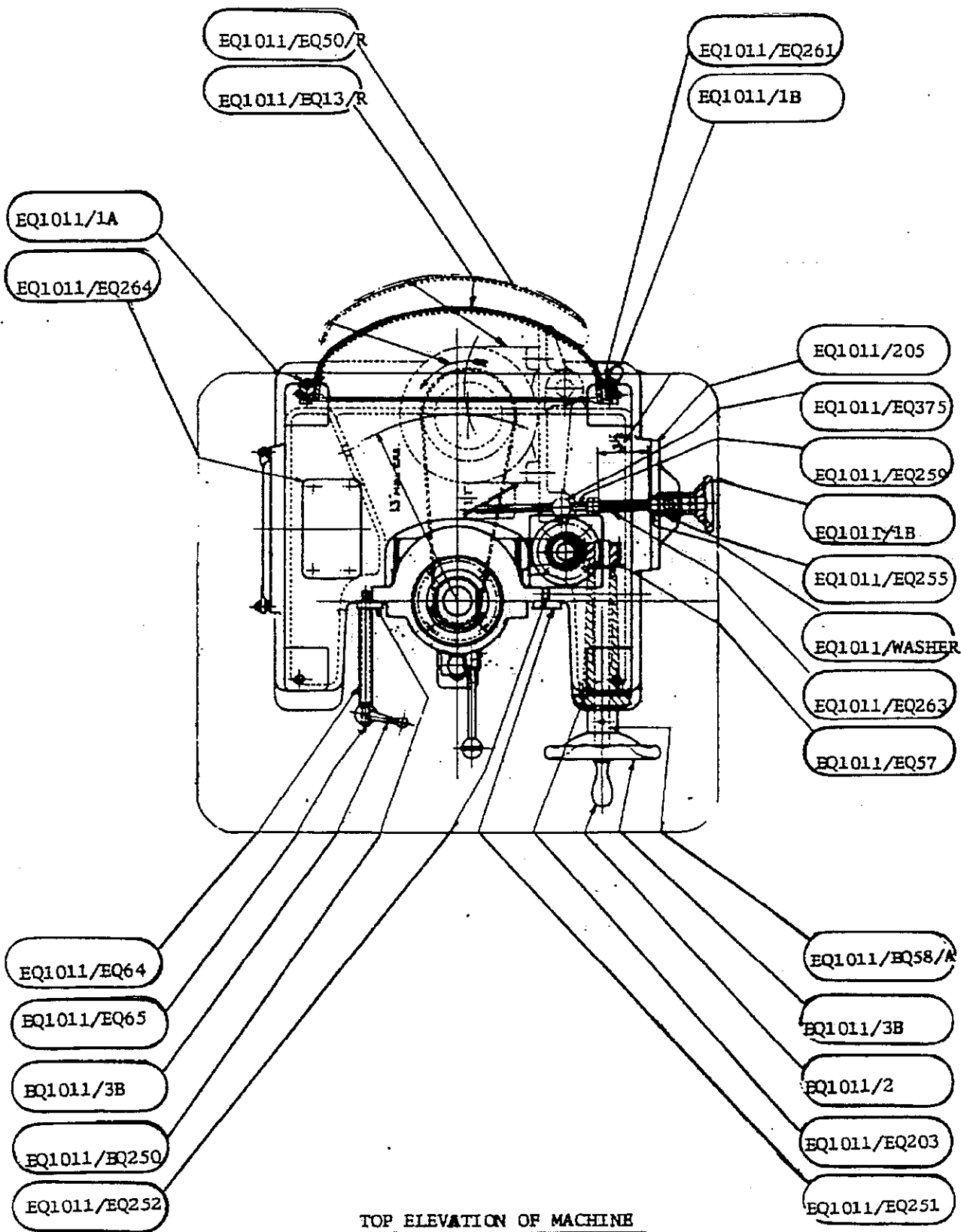

TOP ELEVATION OF MACHINE

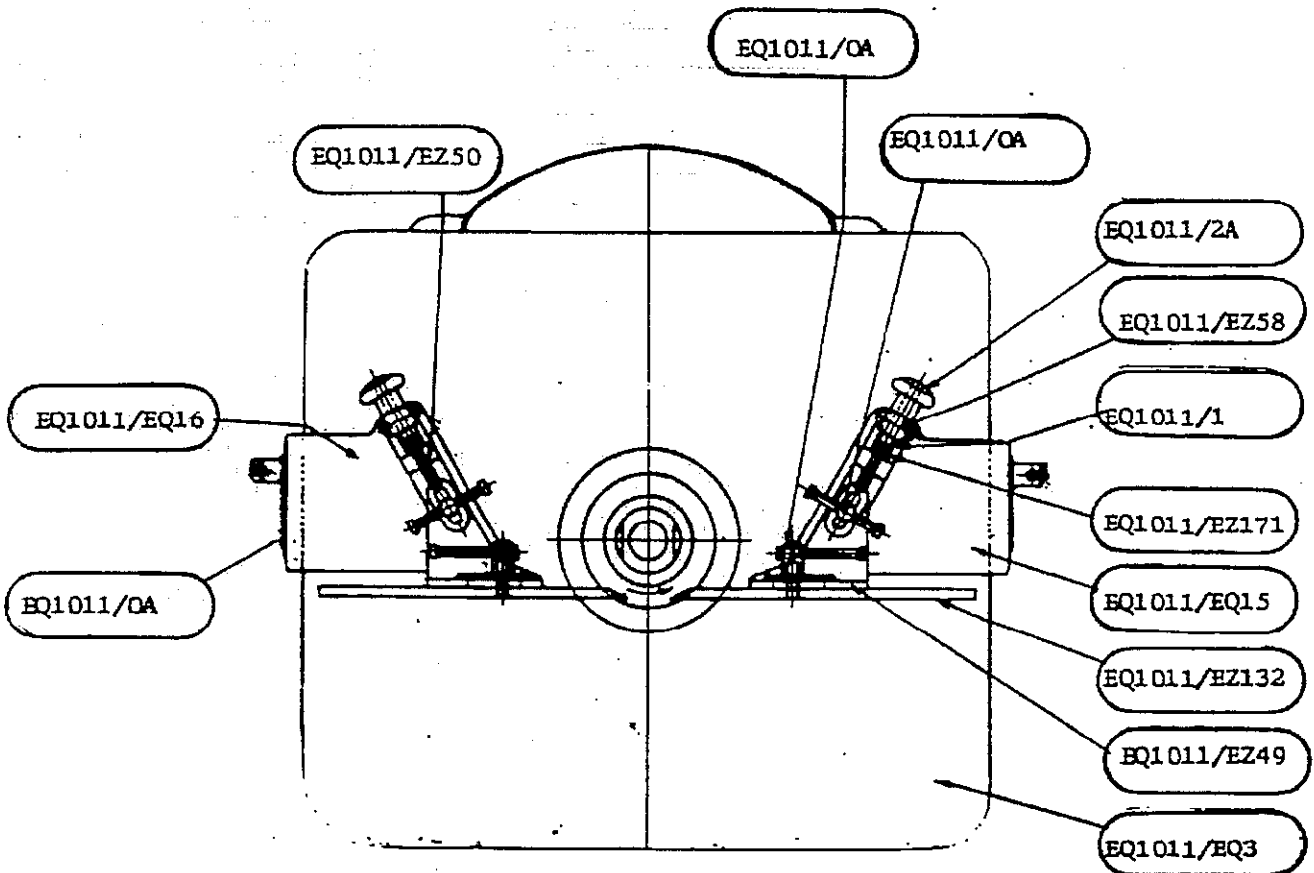

PLAN ELEVATION SHOWING

SPECIAL "PLAIN" TABLE WITH 'E2' TYPE FENCES

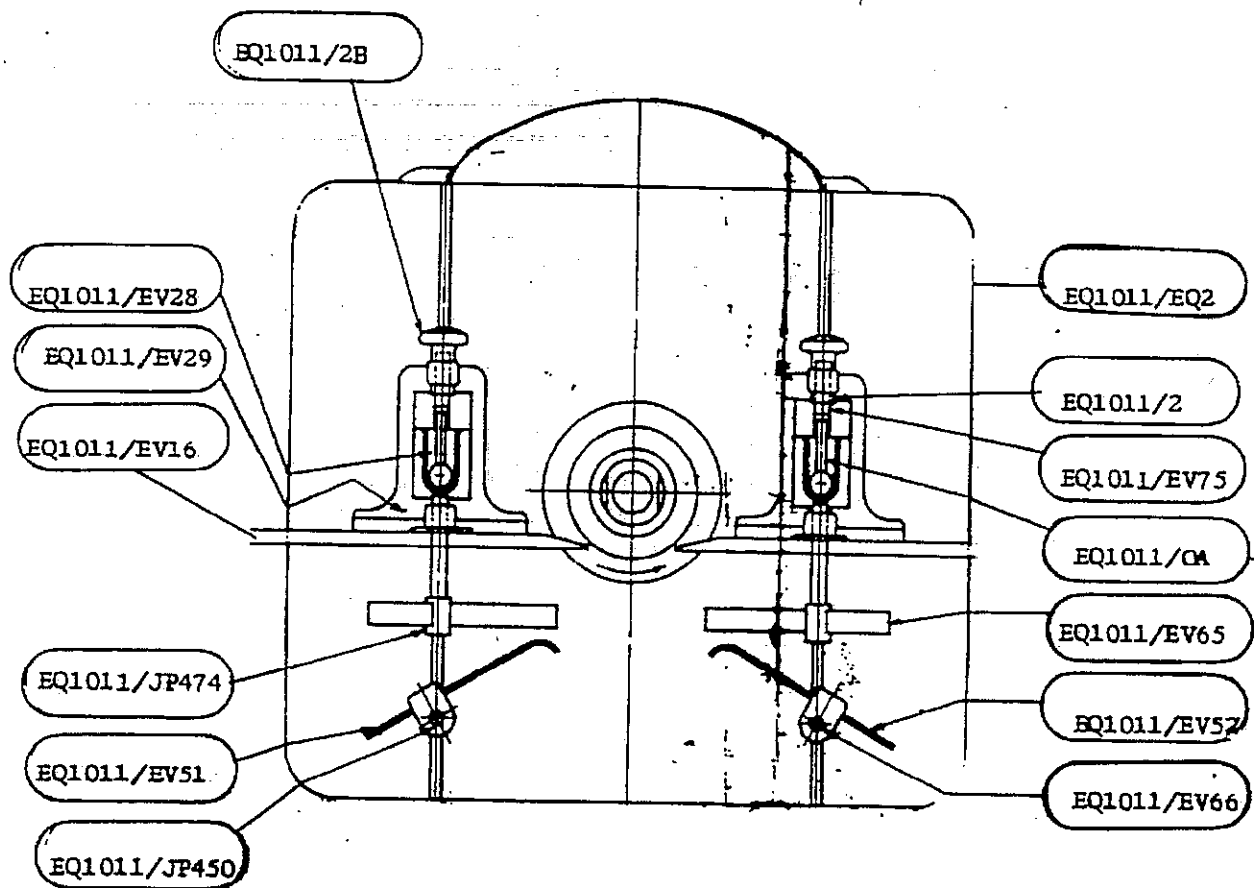

PLAN ELEVATION SHOWING

STANDARD FENCES

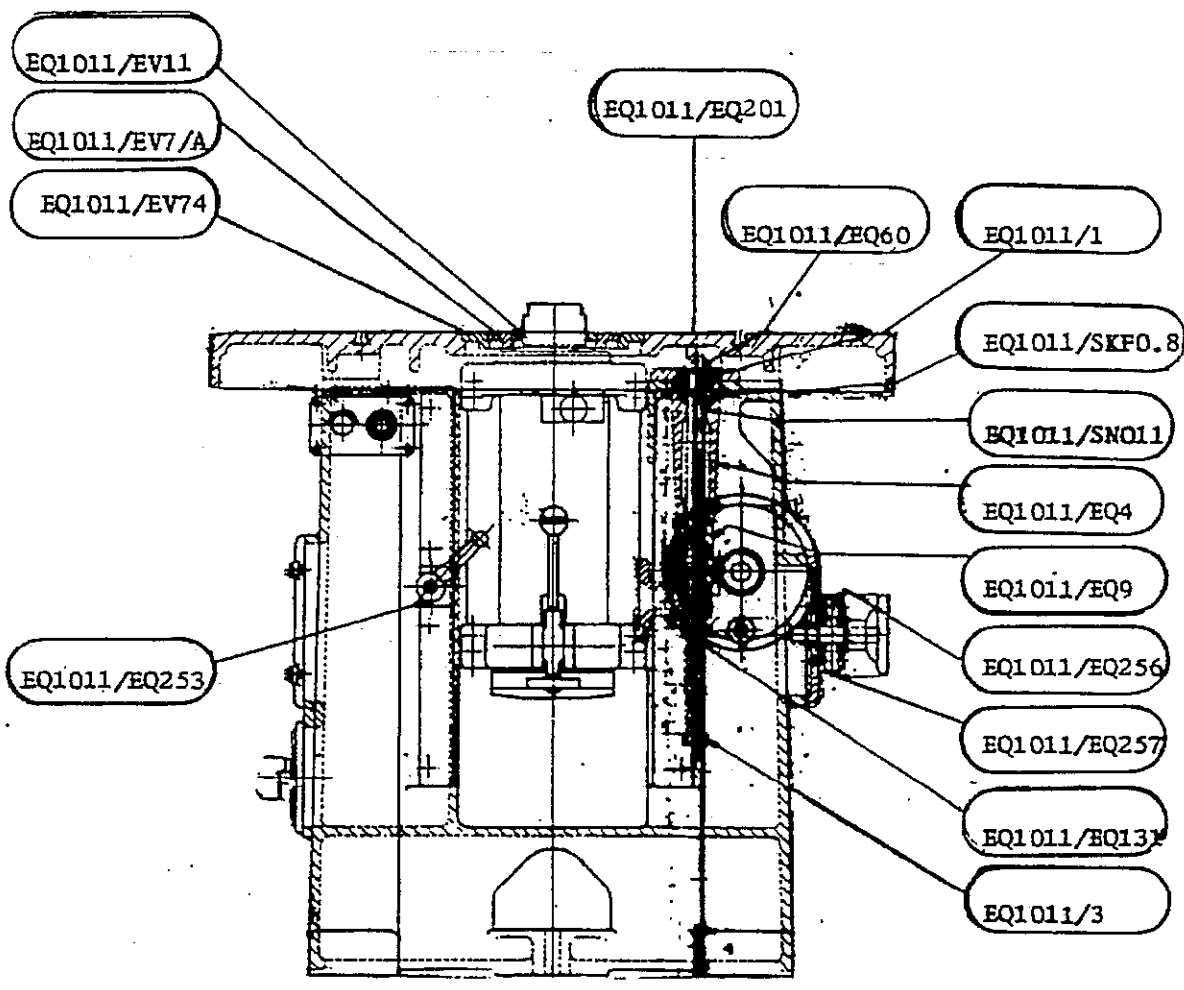

FRONT ELEVATION

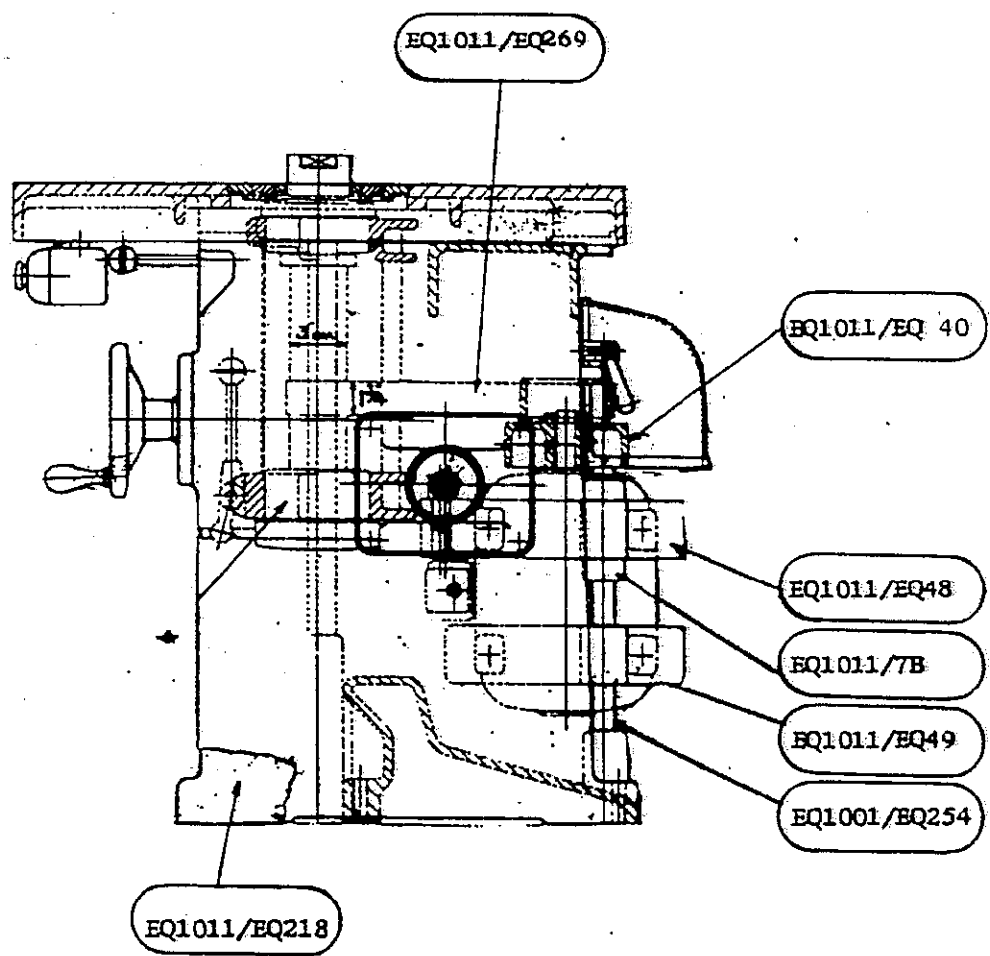

FRONT ELEVATION PLAIN TABLE

VERTICAL SPINDLE MOULDER AND SHAPER EQ